

Evolux Tryphon Complete shower kit

Description

Drain channel and trapped drain, ideal for the construction of site-built shower trays for domestic use and/or collective facilities. Includes integrated waterproofing factory-mounted, consisting of one piece of WATER-STOP waterproof membrane.

Features

- Stainless steel structure
- High load resistance
- Waterproofing included
- High drainage capacity
- Variety of models
- Easy installation
- Effective cleaning
- 10-year warranty

Technical data

- Stainless steel
- PVD and textured finishes

Manufacturer

Estil Guru S.L.U

P.I. El Pla C/ Telers, 22 - Apdo. 584, 46870, Ontinyent,
Valencia, ESPAÑA | www.estilguru.com | guru@estilguru.com
Tel. 0034 96 291 45 11 | Fax. 0034 96 236 90 10

Evolux Lisa



Tryphon	Tryphon Reduced	Description	Finish	Size (cm)	W-S membrane
IT41040	IT41040R	Lisa	●	40	2 x 2 · 4 m ²
IT41050	IT41050R	Lisa	●	50	2 x 2 · 4 m ²
IT41000	IT41000R	Lisa	●	60	2 x 2 · 4 m ²
IT41001	IT41001R	Lisa	●	70	2 x 2 · 4 m ²
IT41002	IT41002R	Lisa	●	80	2 x 2 · 4 m ²
IT41003	IT41003R	Lisa	●	90	2 x 2 · 4 m ²
IT41004	IT41004R	Lisa	●	100	2 x 2 · 4 m ²
IT41005	IT41005R	Lisa	●	120	2 x 2 · 4 m ²
IT41150	IT41150R	Lisa	●	150	2 x 2 · 4 m ²
IT41180	IT41180R	Lisa	●	180	2 x 2 · 4 m ²

Evolux Tryphon Complete shower kit

Evolux Plus



Tryphon	Tryphon Reduced	Description	Finish	Size (cm)	W-S membrane
IT42000	IT42000R	Plus	●	60	2 x 2 · 4 m ²
IT42001	IT42001R	Plus	●	70	2 x 2 · 4 m ²
IT42002	IT42002R	Plus	●	80	2 x 2 · 4 m ²
IT42003	IT42003R	Plus	●	90	2 x 2 · 4 m ²
IT42004	IT42004R	Plus	●	100	2 x 2 · 4 m ²
IT42005	IT42005R	Plus	●	120	2 x 2 · 4 m ²
IT42150	IT42150R	Plus	●	150	2 x 2 · 4 m ²
IT42180	IT42180R	Plus	●	180	2 x 2 · 4 m ²

Evolux Lisa Dark



Tryphon	Tryphon Reduced	Description	Finish	Size (cm)	W-S membrane
IT51000	IT51000R	Lisa Dark	●	60	2 x 2 · 4 m ²
IT51001	IT51001R	Lisa Dark	●	70	2 x 2 · 4 m ²
IT51002	IT51002R	Lisa Dark	●	80	2 x 2 · 4 m ²
IT51003	IT51003R	Lisa Dark	●	90	2 x 2 · 4 m ²
IT51004	IT51004R	Lisa Dark	●	100	2 x 2 · 4 m ²
IT51005	IT51005R	Lisa Dark	●	120	2 x 2 · 4 m ²
IT51150	IT51150R	Lisa Dark	●	150	2 x 2 · 4 m ²
IT51180	IT51180R	Lisa Dark	●	180	2 x 2 · 4 m ²

Evolux Lisa Anti-vandal



Tryphon	Tryphon Reduced	Description	Finish	Size (cm)	W-S membrane
IT41701	IT41701R	Lisa Antivandal.	●	70	2 x 2 · 4 m ²
IT41702	IT41702R	Lisa Antivandal.	●	80	2 x 2 · 4 m ²
IT41703	IT41703R	Lisa Antivandal.	●	90	2 x 2 · 4 m ²

Evolux Tryphon Complete shower kit

Evolux Lisa Gold



Tryphon	Tryphon Reduced	Description	Finish	Size (cm)	W-S membrane
IT61000	IT61000R	Lisa Gold		60	2 x 2 · 4 m ²
IT61001	IT61001R	Lisa Gold		70	2 x 2 · 4 m ²
IT61002	IT61002R	Lisa Gold		80	2 x 2 · 4 m ²
IT61003	IT61003R	Lisa Gold		90	2 x 2 · 4 m ²
IT61004	IT61004R	Lisa Gold		100	2 x 2 · 4 m ²
IT61005	IT61005R	Lisa Gold		120	2 x 2 · 4 m ²
IT61150	IT61150R	Lisa Gold		150	2 x 2 · 4 m ²
IT61180	IT61180R	Lisa Gold		180	2 x 2 · 4 m ²

Test table

Features Hydraulic trap	Method	Requirement	Unit	Value
	EN 1253-1	EN 1253-1		
Drainage flow rate	Article 5.9.1	Article 4.8	l/s	>0.5
Water seal height	Article 5.3.1	Article 4.2.2	mm	50
Water seal resistance to pressure	Article 5.3.2	Article 4.1.6	Pa	>400
Self-cleaning capacity	Article 5.4.2	Article 4.2.2	-	Pass
Clogging prevention	Article 5.4.3	Article 4.2.3	-	Pass
Thermal behaviour	Article 5.5	Article 4.5	-	Class A
Watertightness	Article 5.8.2	Article 4.6.2	-	Pass
Watertightness of the extensions	Article 5.8.2	Article 4.6.3	-	Pass
Odour tightness	Article 5.8.1	Article 4.6.1	-	Pass
Watertightness of the drain used with waterproofing membrane	Article 5.8.3	Article 4.7.3.4	-	Pass
Mechanical strength of the factory-mounted flange / waterproof membrane connection	Article 5.7.3	Article 4.7.3.4	N	>100
Load resistance	Article 5.6	Article 4.7.1	-	Class K3
Openings in the grates (dimensions)	Article 5.1	Article 4.1.3	mm	<8
Appearance	-	Article 4.1.2	-	Pass
Materials	-	Article 4.4	-	Pass

Evolux Tryphon Complete shower kit

Test table

Feature Dry trap	Method	Requirement	Unit	Value
	EN 1253-1	EN 1253-1		
Drainage flow rate	Article 4.11.2	Article 4.11.1	N	>0.8
Closing resistance	Article 4.4.2	Article 4.4.1	-	Pass
Clogging prevention	Article 4.5.1.3	Article 4.5.1.2	mm	Pass
Thermal behaviour	Article 4.8.3	Article 4.8.2	-	Class A
Watertightness	Article 4.9.2.2	Article 4.9.2.1	-	Pass
Odour tightness	Article 4.9.1.2	Article 4.9.1.1		Pass

Technical drawings

Linear channel

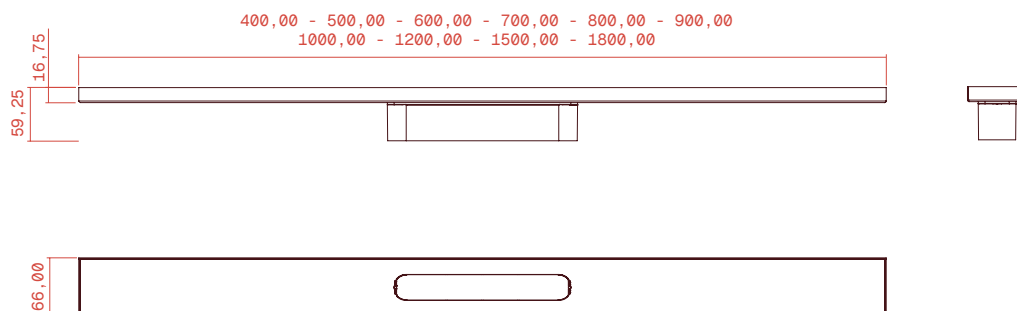

Linear Lisa grate

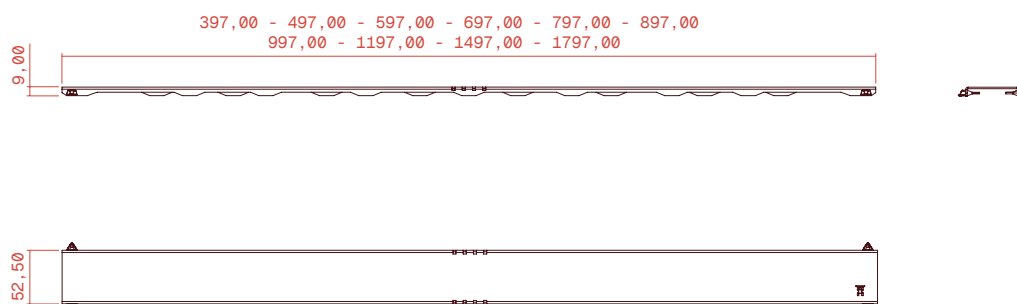

Evolux Tryphon Complete shower kit

Technical drawings

Linear Plus grate

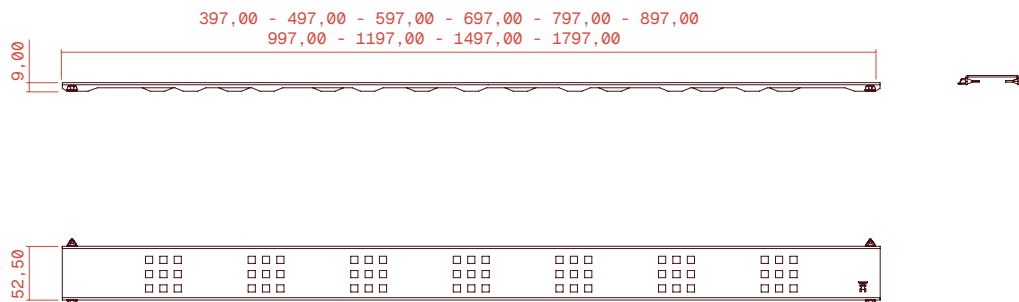

Anti-vandal linear channel

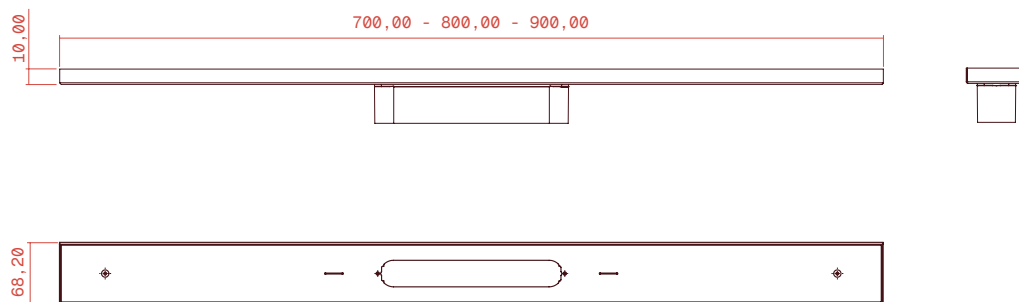

Anti-vandal linear grate

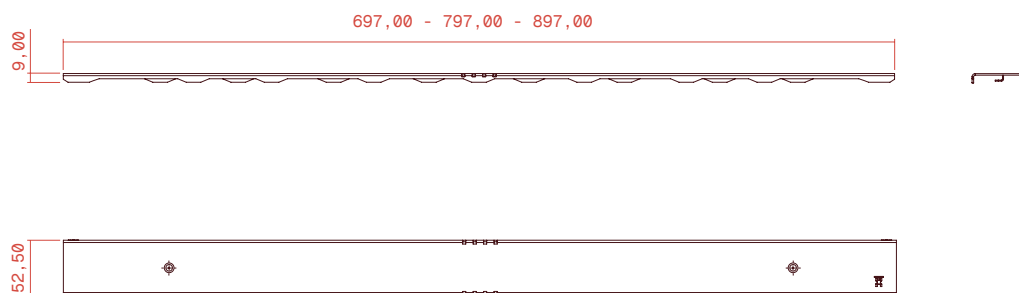

Evolux Tryphon Complete shower kit

Technical drawings (mm)

Tryphon

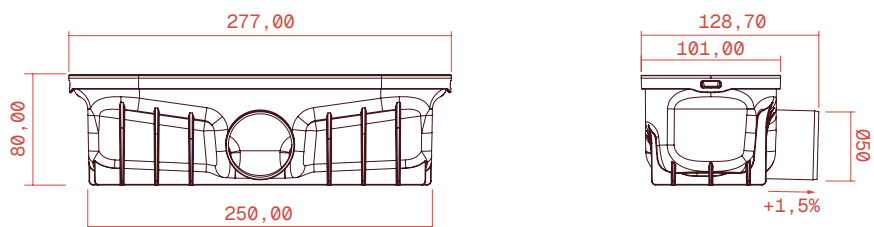

Tryphon Reduced

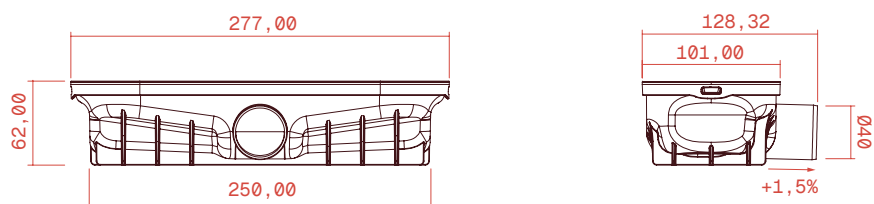

Tryphon Vertical

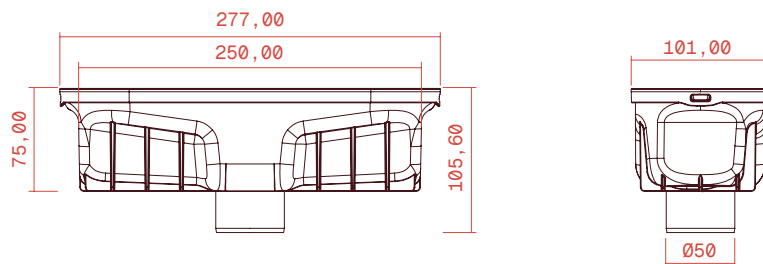

Evolux Tryphon Complete shower kit

Components

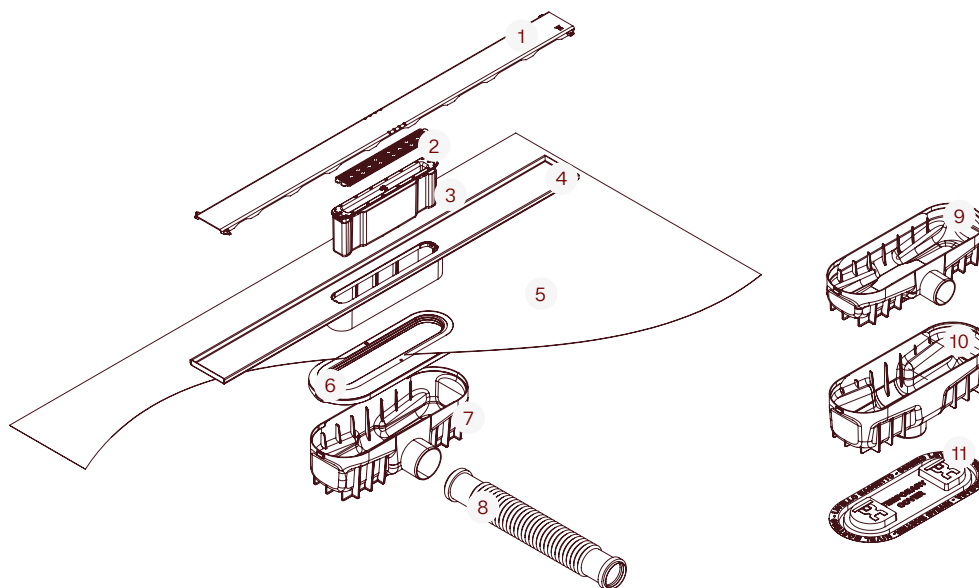

Part	Description	Material
1	Grate (depending on model)	Aluminium
2	Hair strainer	PP
3	Trap*1	ABS/TPU
4	Linear channel	Aluminium
5	WATER-STOP membrane	EVAC
6	Adapter	ABS

Part	Description	Material
7	Tryphon drain	ABS
8	Flexible sleeve*2	PVC
9	Tryphon Reduced drain*3	ABS
10	Tryphon Vertical drain*4	ABS
11	Protective cover	PVC

*1 Two types of trap: hydraulic and dry.

*2 Flexible sleeve Ø50 included in the Tryphon kit and flexible sleeve Ø40 included in the Reduced Tryphon kit | *3 Included only in the reduced kits | *4 Complementary accessory (IG60032).

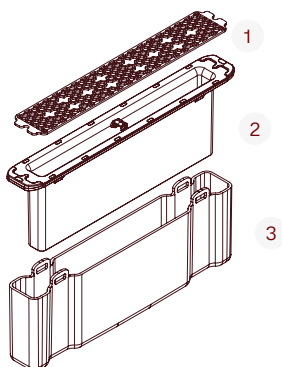

Part	Description	Material
1	Hair strainer	PP
2	Cap (hydraulic trap)	ABS/TPU
3	Cup (hydraulic trap)	ABS

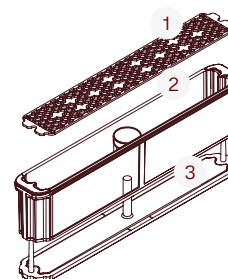

Part	Description	Material
1	Hair strainer	PP
2	Body (mechanical trap)	ABS/TPU
3	Cap (mechanical trap)	PA6

Evolux Tryphon Complete shower kit

Installation section

Tryphon – Ø50 outlet | Accepts both traps: hydraulic or dry.

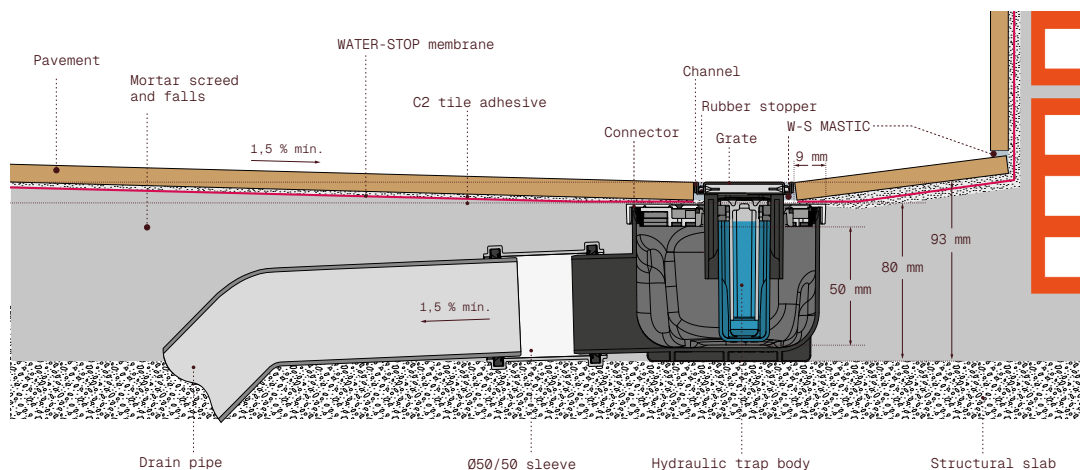

Tryphon Reduced – Ø40 outlet | Accepts dry trap only.

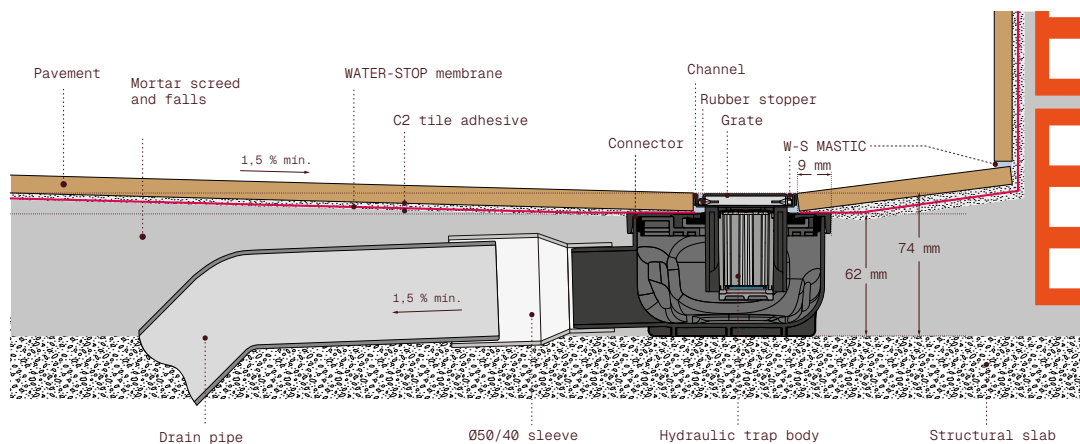

Evolux Tryphon Complete shower kit

Sección de instalación

Tryphon Vertical – Ø50 outlet | Accepts both traps: hydraulic or dry.

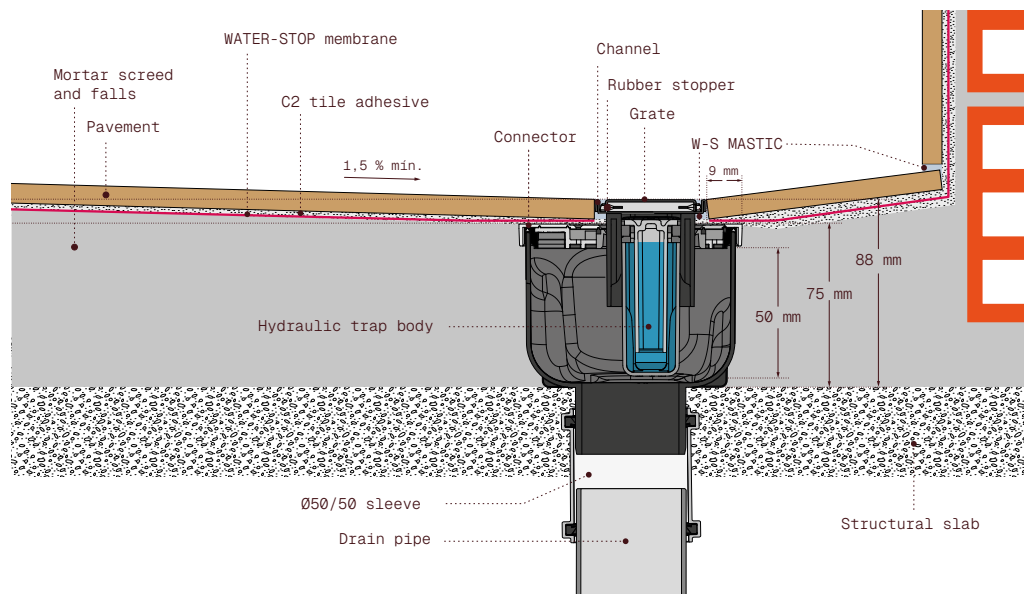

* Complementary accessory: Tryphon Vertical drain body (IG60032).