

GURU COLLECTION

[estilguru.com](http://estilguru.com)

20  
24

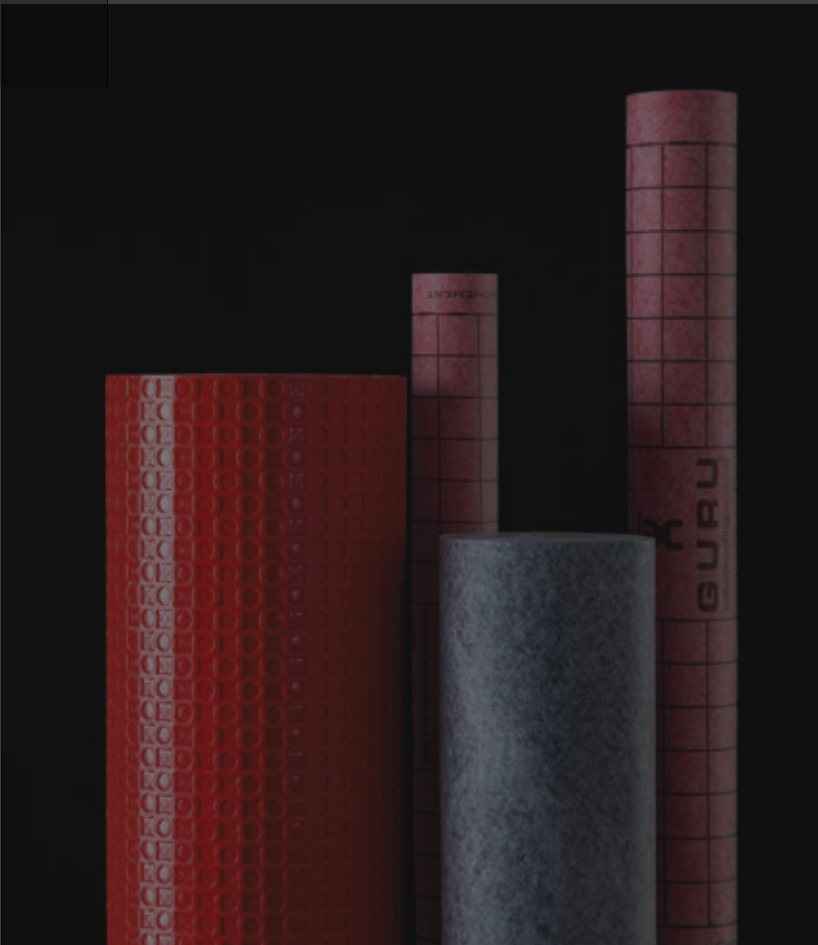

**GURU**<sup>®</sup>  
waterproofingproducts

---

## CONTENTS

06	<b>COMPANY</b> Estil Guru
10	<b>TECHNICAL MEMBRANES</b> Waterproofing, decoupling, and impact
42	<b>ACCESSORIES FOR MEMBRANE INSTALLATION</b> Cement, sealing putty, tools, and special parts for critical points
50	<b>OUTDOOR DRAINAGE SYSTEMS</b> Drainage systems for terraces, roofs, and roof terraces
56	<b>SHOWER SYSTEMS WITH BUILT-IN WATERPROOFING</b> Choose from our extensive catalogue
100	<b>INSTALLATION ACCESSORIES FOR SHOWER SYSTEM</b> Installation accessories and spare parts
104	<b>DRY CONSTRUCTION SYSTEMS</b> Dry construction panels
106	<b>GURU CUSTOMISED</b> Discover how GURU products can form part of your hotel experience
108	<b>GURU SANITARY</b> Our latest innovations for hospitals and nursing homes...
110	<b>BIM OBJECT</b> Guru products on the BIM object platform
112	<b>INSTALLATION GUIDES AND VIDEOS</b> QR code to our product guides and videos
114	<b>ADVERTISING AND MARKETING</b> Enhance our brand using our marketing tools
118	<b>FEATURED PROJECTS</b> On Estil Guru's important works
142	<b>TERMS AND CONDITIONS</b> General terms and conditions for shipping and logistics

# ILLUSTRATED TABLE OF CONTENTS

## TECHNICAL MEMBRANES

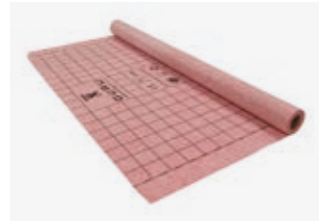

**WATER-STOP**  
Pages 12-27

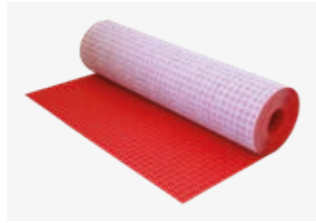

**G-FLEX**  
Pages 28-35

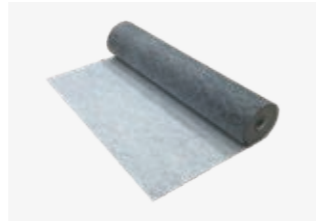

**G-SOUND**  
Pages 36-39

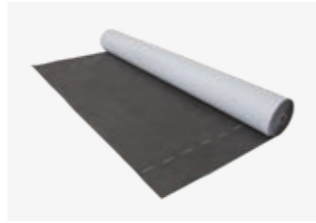

**W-S AIR**  
Pages 40-41

## ACCESSORIES FOR MEMBRANE INSTALLATION



**SAFE BAND**  
Pages 44-47

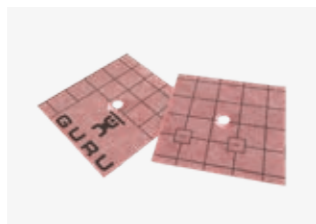

**W-S TUB**  
Page 42

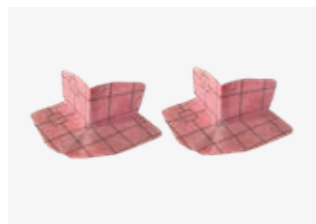

**W-S DEX**  
Page 42

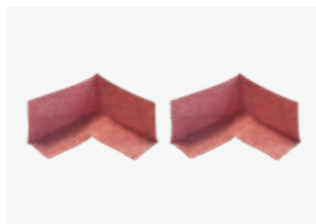

**W-S DIN**  
Page 42



**W-S BAND 14 / 34**  
Page 42

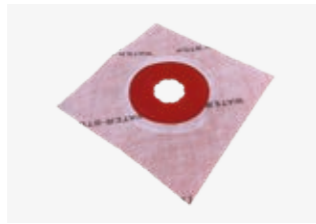

**SAFETUB**  
Page 42

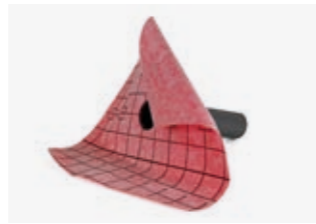

**W-S PASSTUB**  
Page 42



**G-TROWEL**  
Page 43



**W-SPATULA**  
Page 43



**EASEAL**  
Page 43



**W-S BUTIL**  
Page 43



**W-S MASTIC**  
Page 43

## OUTDOOR DRAINAGE SYSTEMS



**RAYNEX**  
Pages 50-53



**W-S KIT TERRACE**  
Page 54



**W-S KIT TERRACE PLUS**  
Page 55

## SHOWER SYSTEMS WITH BUILT-IN WATERPROOFING



**DRAIN TRYPHON**  
Pages 58-59

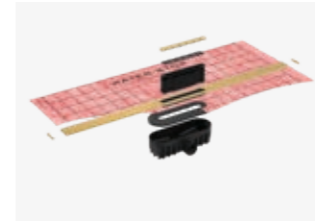

**REVOLUX TRYPHON KIT**  
Pages 60-65



**EVOLUX TRYPHON KIT**  
Pages 66-75



**EVOLUX INTEGRA TRYPHON KIT**  
Pages 76-79



**DRAIN RUBER**  
Pages 80-81



**EVO RUBER KIT**  
Pages 82-85



**EVOLUX RUBER KIT**  
Page 86-91



**REVOLUX RUBER KIT**  
Pages 92-93



**EVOLUX VINYL**  
Pages 94-95



**W-S BATHKIT**  
Pages 48-49

## INSTALLATION ACCESSORIES FOR SHOWER SYSTEM



**EVOLUX SHELF**  
Pages 96-99



**JOINT BRACKET**  
Page 100



**RUBER VERTICAL OUTPUT KIT**  
Page 100

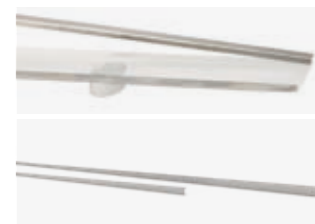

**G-PRO WALL / G-PRO LEVEL**  
Page 101

## DRY CONSTRUCTION SYSTEMS

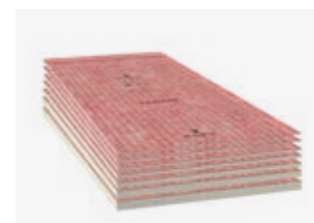

**W-S BOARD**  
Pages 104-105

# CONTINUOUS EVOLUTION TOWARDS EXCELLENCE

ESTIL GURU S.L.U. is a well-established family company in the **construction sector** with a proven track record in the market and strong business stability. The company has grown through the manufacturing and marketing of **waterproofing products**.

GURU's goal is to integrate **innovative products**, supported by thorough research, into new proposals for construction solutions. This approach drives us to create dependable products that meet our customers' expectations while providing the necessary personal and technical support.

**With a presence in five continents**, Estil Guru boasts an exceptional team and extensive experience in manufacturing waterproofing membranes, Italian-style shower systems for on-site showers, and various accessories for professional ceramic tile installers. Our products meet the highest quality **standards** set by the European Union and are certified by external laboratories such as IAPMO, CSTB and KIWA.

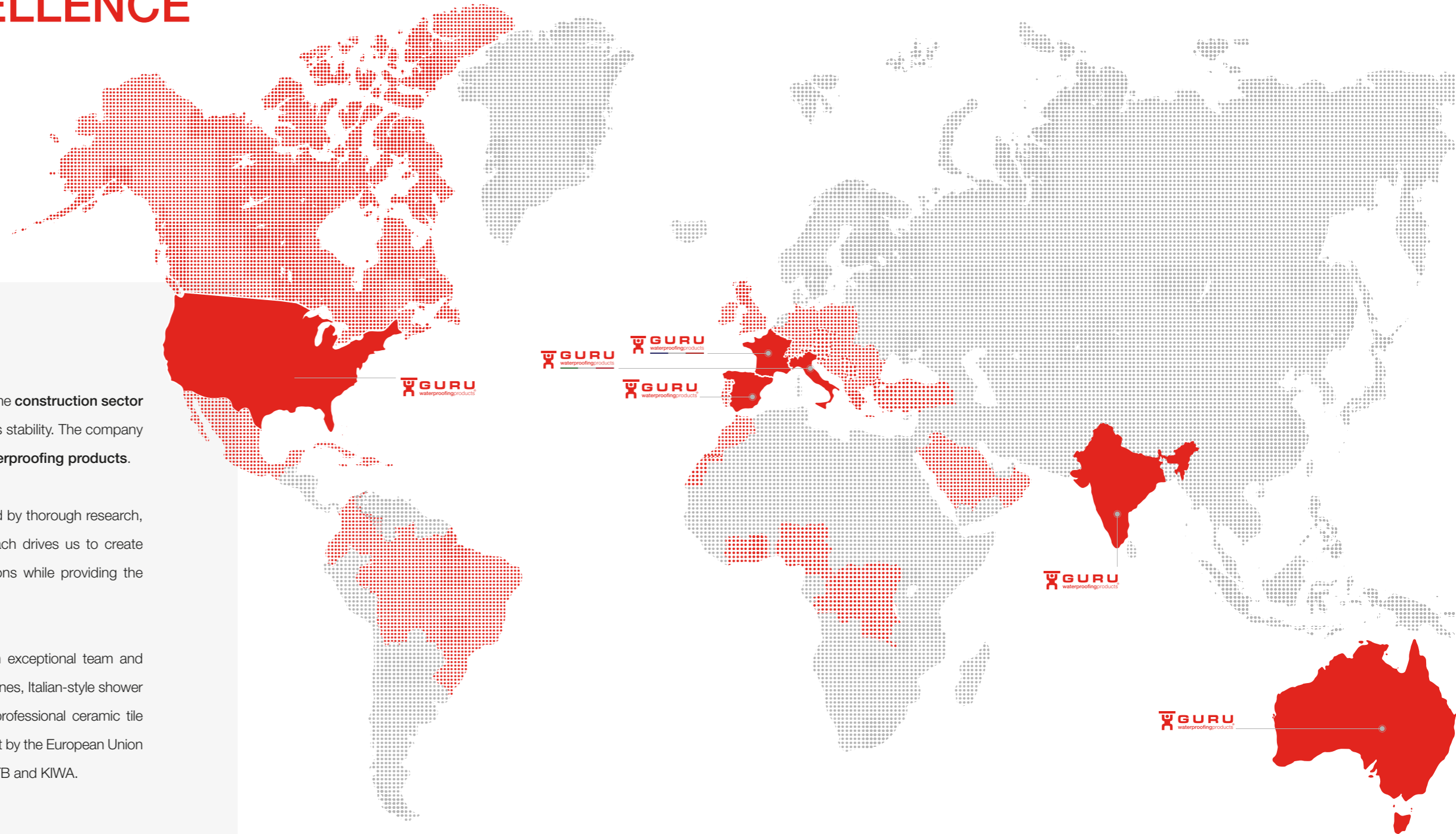

**+3000**  
POINTS OF SALE





## Estil Guru passes the EDP with flying colours!

At Estil Guru, we are proud to inform you that we have obtained the EPD. This objective evaluation shows the environmental impact of our WATER-STOP product.

### The EPD is not just a certification, but also a commitment to the environment

The **Environmental Product Declaration** is a thorough evaluation that examines the environmental impact of a product throughout its entire life cycle. At Estil Guru, we aim for both high performance and transparency. By obtaining and sharing the EPD, we demonstrate our commitment to accurately assessing the environmental impact of our products.

### Key points analysed in the EPD:

1. **Raw material extraction:** our WATER-STOP waterproofing membrane is manufactured using responsibly selected raw materials to minimise the impact on biodiversity.
2. **Production process:** we use advanced, energy-efficient technologies to eliminate emissions and optimise every stage of the manufacturing process.
3. **Sustainable packaging:** we aim to reduce waste by using recyclable and minimalist packaging materials.
4. **Product Lifetime:** our WATER-STOP waterproofing film is designed for long-lasting performance and reduces the need for replacement, minimising waste generation.
5. **End-of-life:** we design our products with materials that can be easily separated and processed at the end of their useful life, making recycling more efficient.

### WATER-STOP: unrivalled performance, guaranteed sustainability

- » Versatile uses: whether for showers, terraces, shelters or swimming pools, WATER-STOP is the ultimate choice for waterproofing. This product's advanced formula creates a water-resistant barrier that effectively and durably protects every corner of your space.
- » EPD: certified environmental success: the WATER-STOP waterproofing membrane offers an unparalleled solution for your waterproofing needs while promoting environmental responsibility. Every aspect of the product's life cycle has been carefully analysed, from the extraction of raw materials to its end of life, to ensure optimal environmental impact and sustainability.
- » Exceeding all points of the EPD: WATER-STOP stands out by exceeding all critical points assessed in the environmental product declaration. Our commitment to environmental excellence is reflected in every aspect of our operations, from responsible raw material selection to efficient production processes and sustainable packaging.
- » Extra sustainability: Estil Guru WATER-STOP is distinguished by its use of up to 60% less plastic than its competitors, demonstrating our commitment to reducing plastic waste without compromising on performance or protection. Furthermore, due to its extended shelf life, there is no need for product refurbishment or renewal.

### Specific applications:

6. **Showers:** WATER-STOP creates an impenetrable barrier in showers, preventing leaks and protecting underlying structures from water damage.
7. **Terraces:** transform your terrace into a water-resistant space with WATER-STOP. This product provides a durable protective layer against the elements.
8. **Shelters:** shelters are protected from leaks and dampness thanks to advanced WATER-STOP technology, reducing the cost of repairing structural risks caused by dampness.
9. **Swimming pools:** WATER-STOP waterproofing film is the ideal choice for preserving the surrounding structure of your pool and resisting water, keeping it in perfect condition.

### Estil Guru: protection, innovation and environmental commitment

By choosing WATER-STOP, you not only ensure a superior waterproofing solution for your most precious spaces, but you also contribute actively to the preservation of the environment. WATER-STOP is a highly sustainable waterproofing solution, as verified by EPD. Join us on the journey towards sustainability, where performance excellence meets environmental responsibility.





# AT THE FOREFRONT OF WATERPROOFING



More flexible



More resistant



Longer duration



Easier to install



Greater time savings

At Estil Guru, innovation is at the core of our mission. We are proud to have pioneered the design of waterproof EVAC-type membranes using the combined extrusion method.

Our waterproofing membranes are designed to cover all areas of home waterproofing, including exteriors, interiors, and swimming pools.

Each of our geotextile waterproof membranes is designed, engineered, and manufactured to achieve unique specifications.

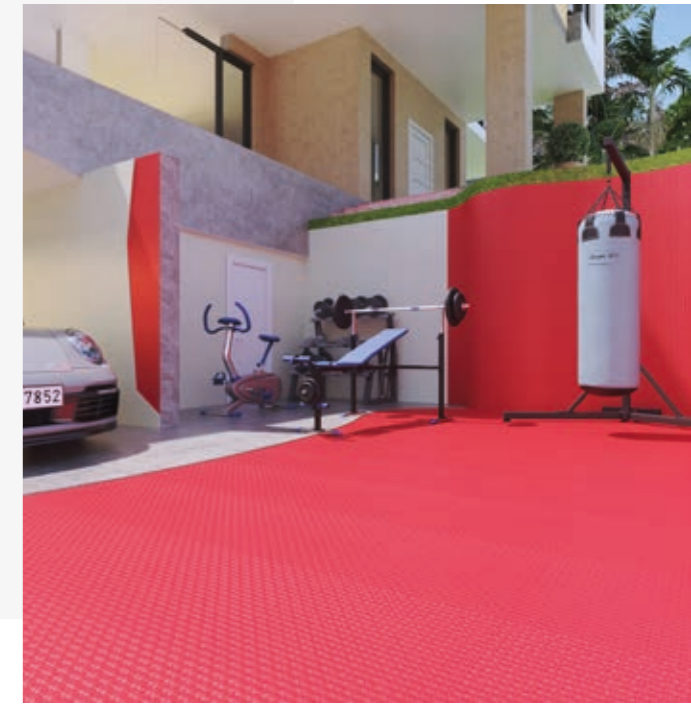

Learn more about our waterproof membranes





WATERPROOF MEMBRANE **WATER-STOP**



Scan the QR code and discover more

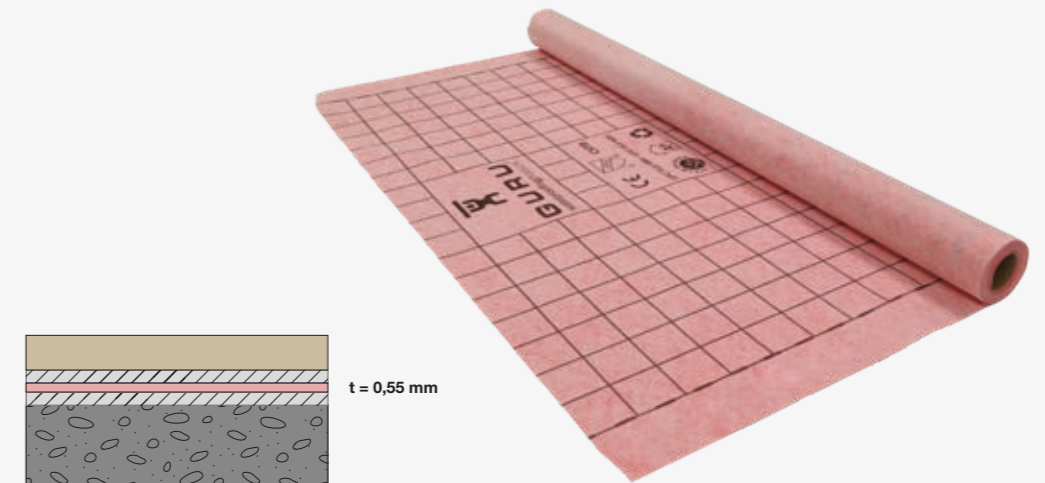

**Features**

- » High mechanical grip
- » Bridges cracks and allows small movements.
- » Minimum installation height
- » Lightweight and safe
- » More flexible than most waterproof membranes
- » Easy installation
- » Excellent for both new builds and renovations
- » Economical and reliable solution

**Specifications**

- » Weight/m<sup>2</sup> (gr): 250
- » Width (m): 1, 1'5, 2, 3
- » Length (m): 5, 10, 20, 30, 40
- » Pull out:  
≥ 0,7 N/mm<sup>2</sup> = ≥ 70 tons/m<sup>2</sup>



**CSTB**  
AVIS TECHNIQUE CSTB – NORMATIVE  
REF.: EN 13956:2013

- Non-woven fibres:  
- 50% polyester  
- 50% polypropylene.
- Double layer of waterproof EVAC.

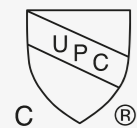

WATER-STOP is a **thin** and **elastic** geotextile membrane that is **ideal for waterproofing** floors and walls under the lining.

It consists of **several layers**; in the centre a waterproof membrane made of two layers of plastic film (EVAC) and a non-woven fleece of polyester and polypropylene fibres on each side.

**A MEMBRANE CAPABLE OF ANYTHING**

**INDOOR**



**OUTDOOR**



**SWIMMING POOLS**



**4 Layers Superior Technology**





## SIZE MATTERS

At GURU, we believe that size is important, especially when it comes to our new 3-metres high WATER-STOP film roll. Thanks to this new size, you can achieve **perfect adaptability** for both small and large projects. Furthermore, this new format offers flexibility and **optimises installation time, cost, and material** by reducing the number of joints required for installation.

**+ SIZE**  
**+ ADAPTABILITY**



**- WASTE**  
**- OVERLAPS**  
**- RISK**

## AVAILABLE SIZES

Available in a **variety** of roll sizes to suit your needs, discover limitless versatility with our range of WATER-STOP waterproofing membranes. Our wide range of options gives you the flexibility to achieve accurate and efficient application from small projects to large areas. Designed to offer bespoke solutions, the unparalleled adaptability of our rolls will simplify your sealing experience.

PRODUCT			LOGISTICS		
REF.	DESCRIPTION	MEASURE	WEIGHT/ROLL	PCS/BOX	PCS/PALLET
IF55039	WATER-STOP BAG	1,5 x 2 · 3 m <sup>2</sup>	1 kg	-	-
IF51000	WATER-STOP ROLL	1 x 5 m · 5 m <sup>2</sup>	1,6 kg	12	200
IF51013	WATER-STOP ROLL	1 x 10 m · 10 m <sup>2</sup>	3,2 kg	10	200
IF52000	WATER-STOP ROLL	1 x 30 m · 30 m <sup>2</sup>	8,7 kg	4	100
IF54000	WATER-STOP ROLL	1,5 x 20 m · 30 m <sup>2</sup>	8,7 kg	5	100
IF53000	WATER-STOP ROLL	2 x 20 m · 40 m <sup>2</sup>	11,7 kg	4	100
<b>NEW</b> IF63000	WATER-STOP ROLL	3 x 20 m · 60 m <sup>2</sup>	15,6 kg	4	100
IF53040	WATER-STOP ROLL	2 x 40 m · 80 m <sup>2</sup>	23,4 kg	2	100

# UP TO 3 METRES HIGH!





**RENOVATIONS ARE NO LONGER A PROBLEM!**

WATER-STOP is a minimum 2cm thick waterproofing membrane without additional layers. Ideal for the renovation of terraces and balconies where other types of waterproofing have deteriorated. Solves problems such as leaks and stains caused by damp conditions. Its advantage is that it does not exceed the height of the access to the houses and **can be installed directly on the existing pavement**. It simplifies the renovation process, maximises efficiency and ensures a flawless finish.



**BRIDGES CRACKS AND ALLOWS SMALL MOVEMENTS**

Although WATER-STOP forms a system with the substrate and coating, the **elasticity** of the inner waterproof membrane combined with the elasticity of the fibres provides a **decoupled** effect, allowing each element to expand and contract independently

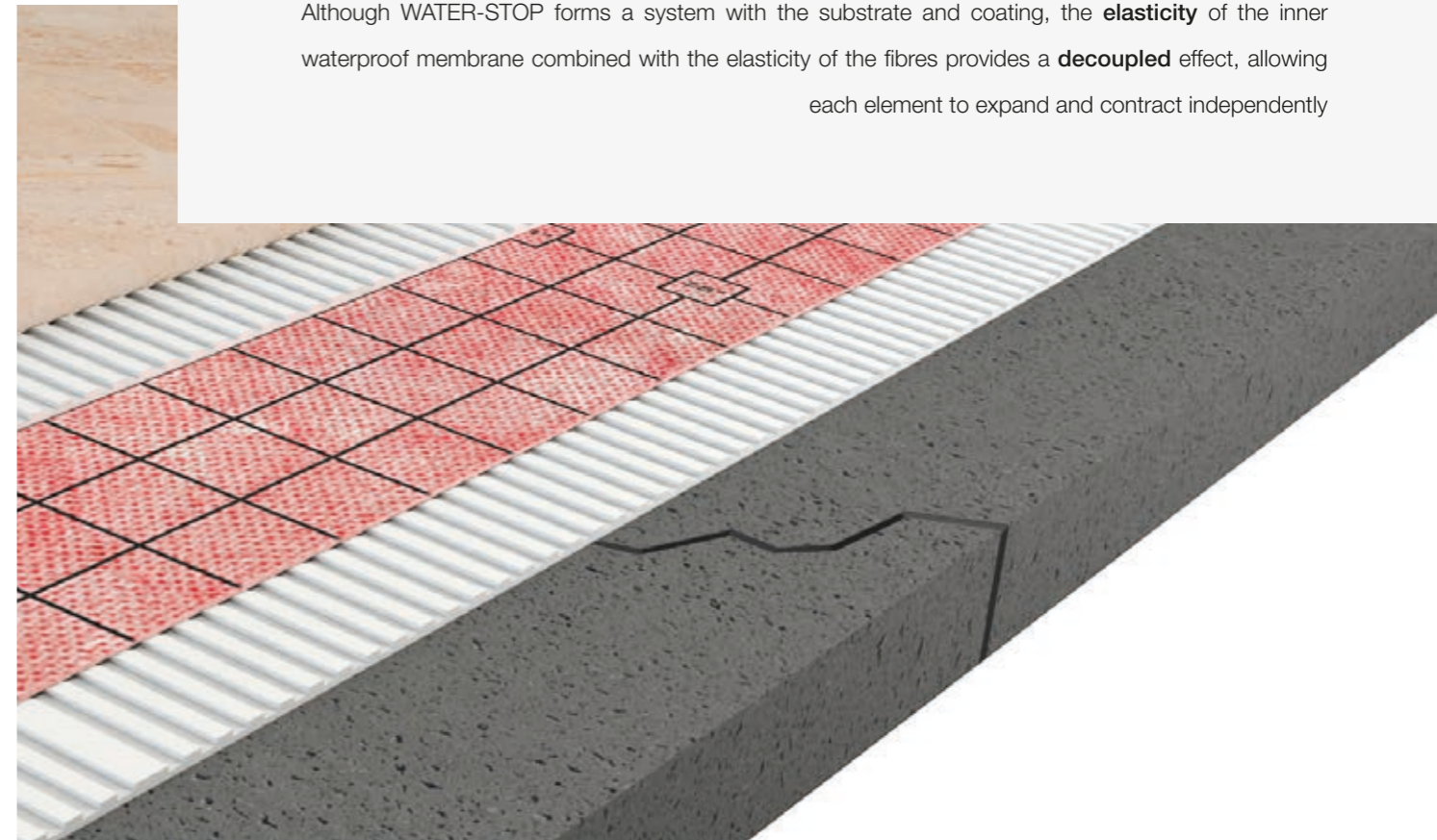

**HIGH MECHANICAL GRIP**

Thanks to its high mechanical grip, the sheet is bonded to the substrate and the coating is bonded directly to the sheet, making the assembly **cohesive and strong**, eliminating the need for a compression layer in flooring applications and eliminating the problems associated with **wall applications**.

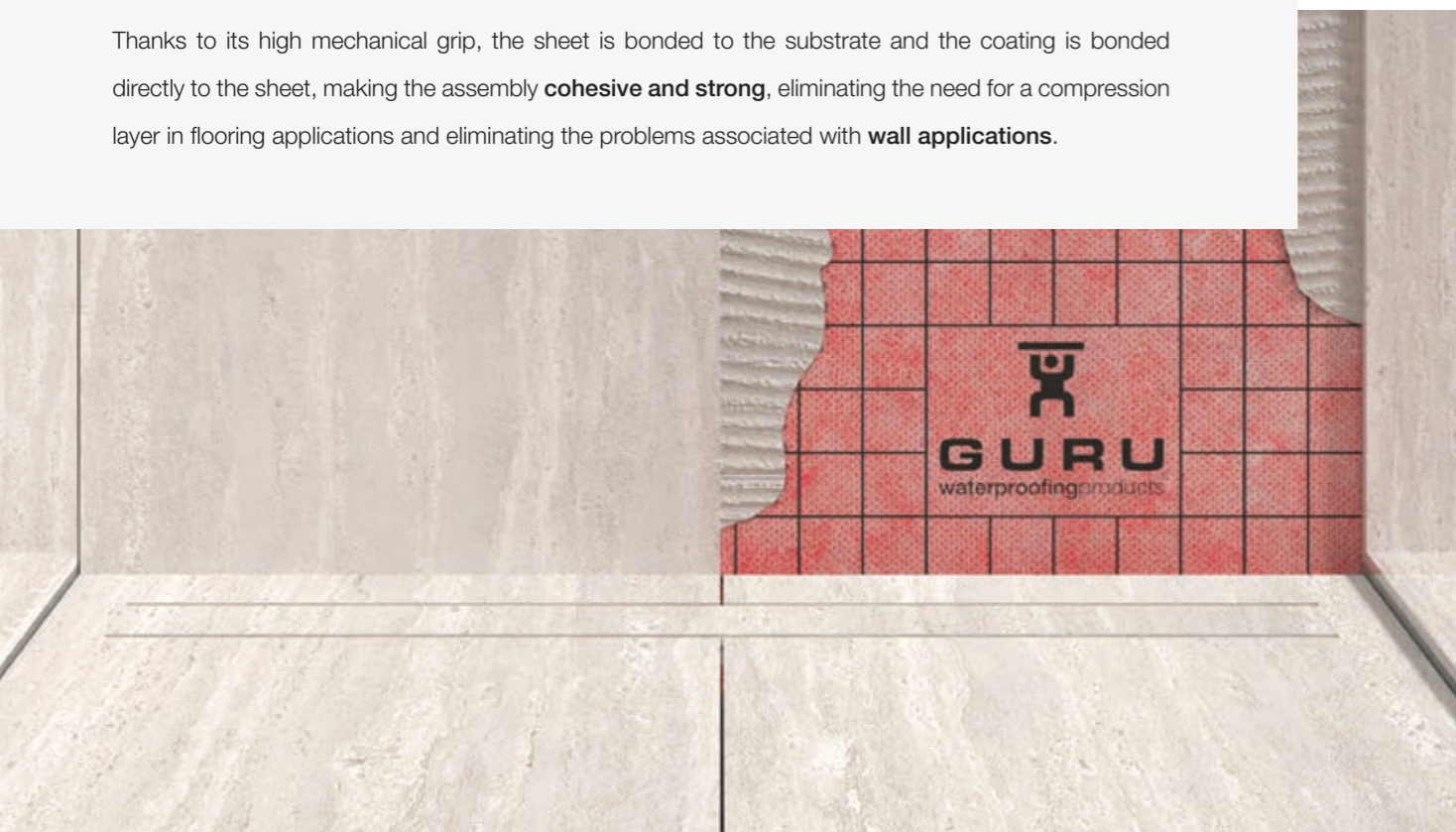

**MUCH MORE FLEXIBLE THAN ANY OTHER WATERPROOFING MEMBRANES**

With WATER-STOP, it is easier to solve the most **complicated points** of any installation, such as corners, floor-to-wall joints, joints with building elements...





# WHY CHOOSE WATER-STOP?

## ANALYSIS OF GENERAL WATERPROOFING METHODS:

**WATER-STOP:** a film composed of 4 polymer layers, 2 inner layers of polyethylene in film form and 2 outer layers of fibre for mechanical anchoring of cement.

**ASPHALT:** bituminous membranes that are manufactured by impregnating paper or fibreglass matting with pitch or bitumen and added with plasticisers.

**LIQUID APPLIED WATERPROOFING:** products made from dissolved polymers. The materials used for this purpose can be rubber or polyurethane-based, polyureas, or waterproof cements.

The polymers that make up WATER-STOP do not degrade once installed. They retain their properties permanently. Asphalts require additive plasticizers, but these deteriorate over time and the asphalt loses elasticity and becomes brittle. Paints cannot withstand the constant mechanical stress of weathering. They will eventually crack.

The WATER-STOP has a life expectancy that can be guaranteed by the factory for as long as the specified requirements are met.

Liquid waterproofing is easier to install but weighs four times more than WATER-STOP.

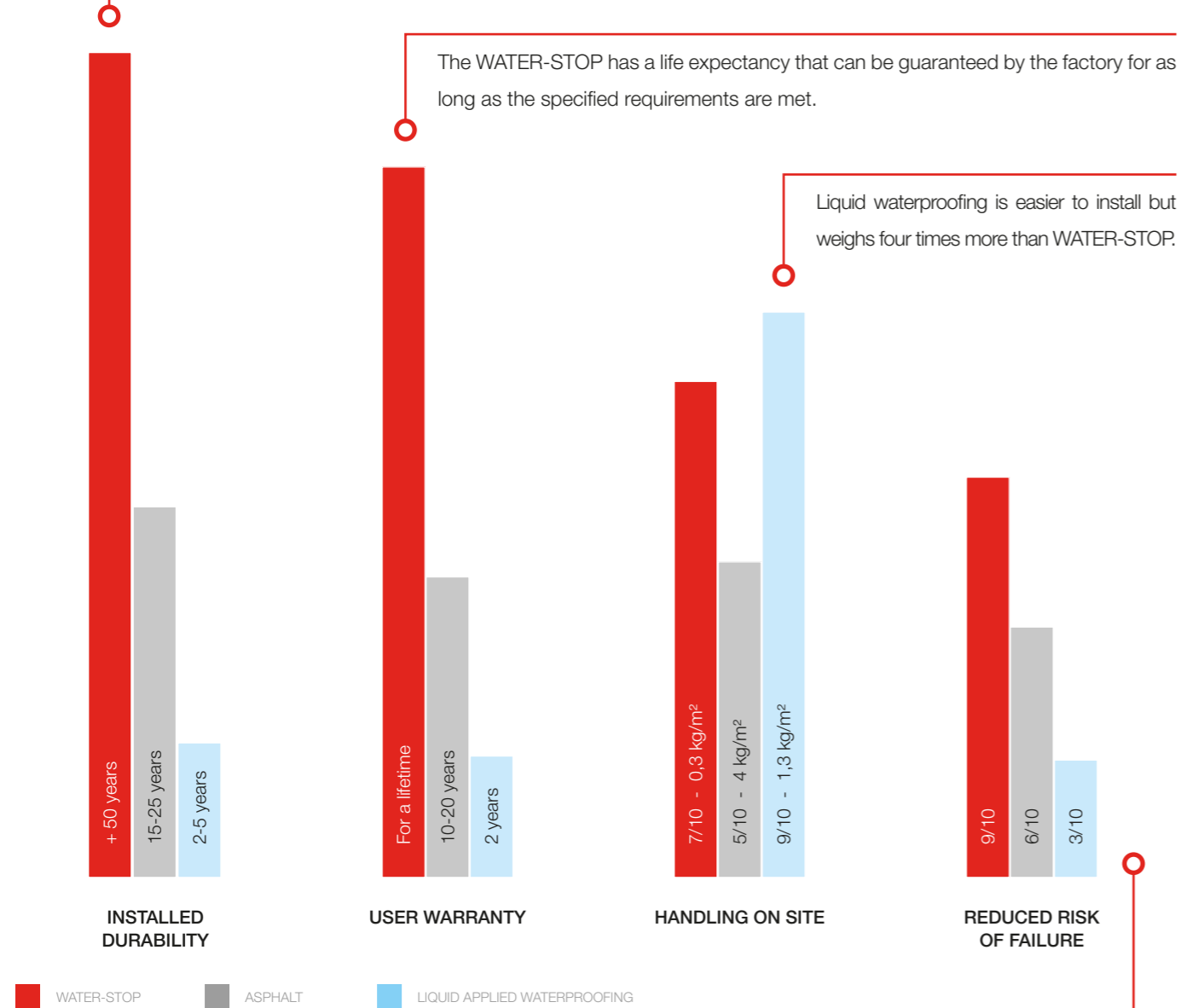

Liquid waterproofing, although easy to install, carries a higher risk than waterproofing membranes, which ensure watertightness through controlled and audited production processes. In addition, the expected result of liquid sealing can be altered by environmental factors such as humidity, temperature or wind. WATER-STOP is bonded without the need for heat application, unlike asphalt, reducing the risk involved.

## INSTALLATION FEATURES

### 1. HEIGHT

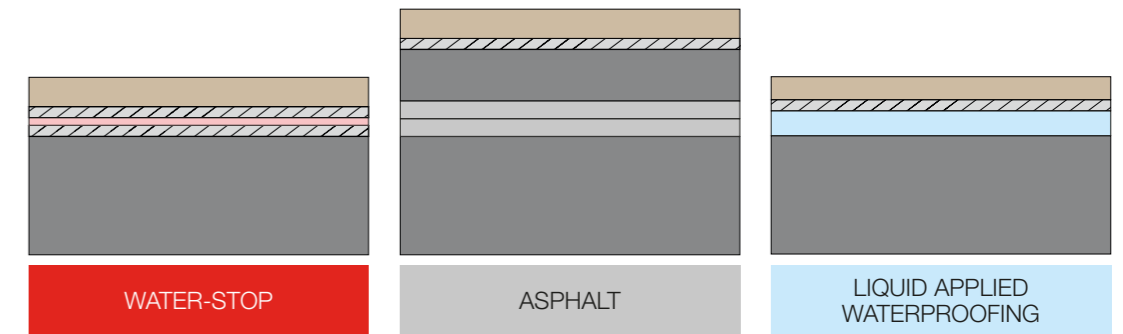

	WATER-STOP	ASPHALT	LIQUID APPLIED WATERPROOFING
TOTAL HEIGHT	2 cm	7 cm	2 cm
WEIGHT	25-30 kg/m <sup>2</sup>	120-180 kg/m <sup>2</sup>	30-35 kg/m <sup>2</sup>
TIME	20 mins/m <sup>2</sup>	50 mins/m <sup>2</sup>	35 mins/m <sup>2</sup>
INSTALLATION TIME	Same day	3-5 days	2-3 days

### 2. RESOURCES NEEDED



### 3. SUSTAINABILITY

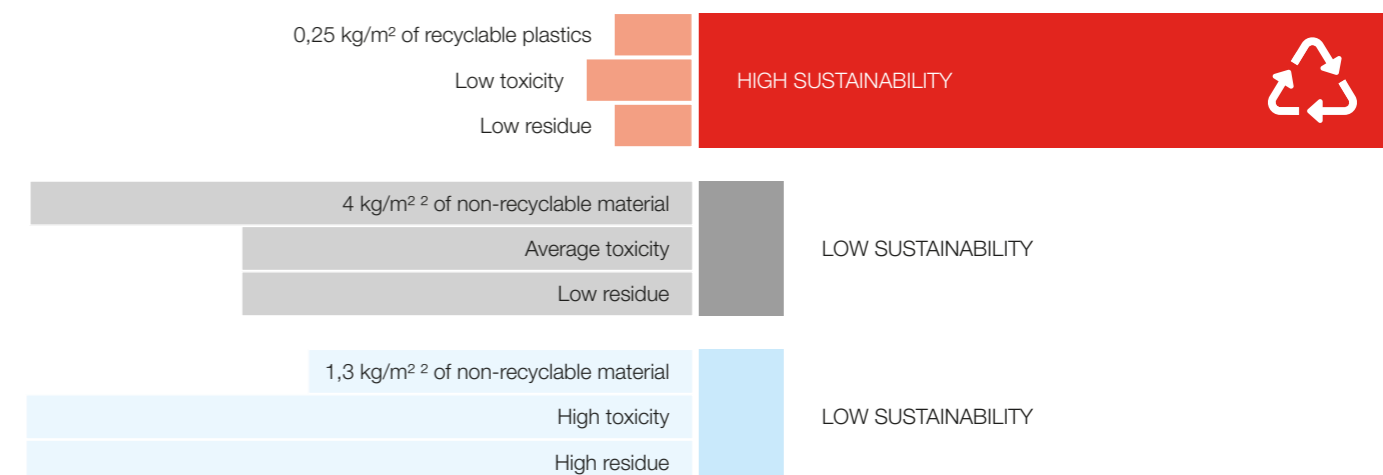

## WHY CHOOSE WATER-STOP?

ANALYSIS OF GENERAL WATERPROOFING METHODS (SOURCE: **CYPE**): 

### 1. PRODUCT PRICE / M<sup>2</sup>

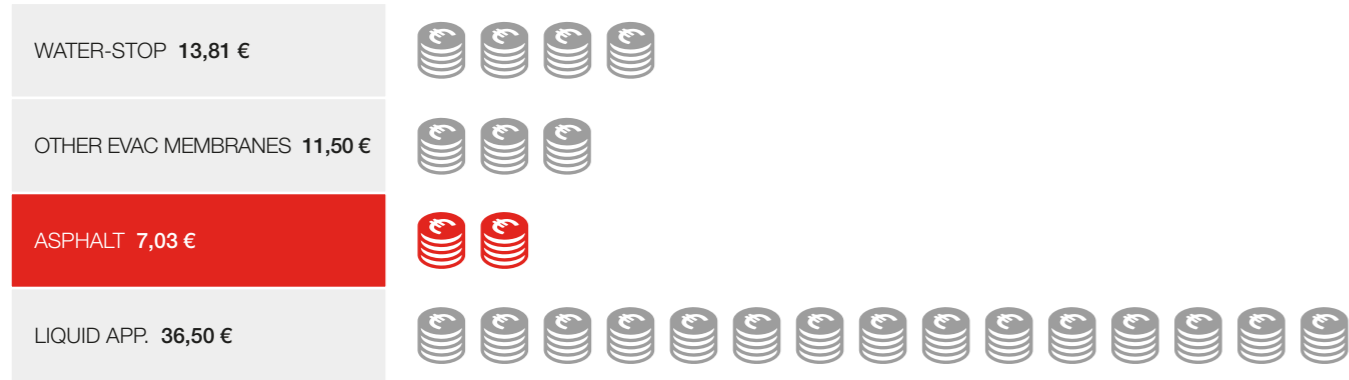

### 2. LABOUR: AVERAGE TIME / OPERATOR COST VALUE / M<sup>2</sup>

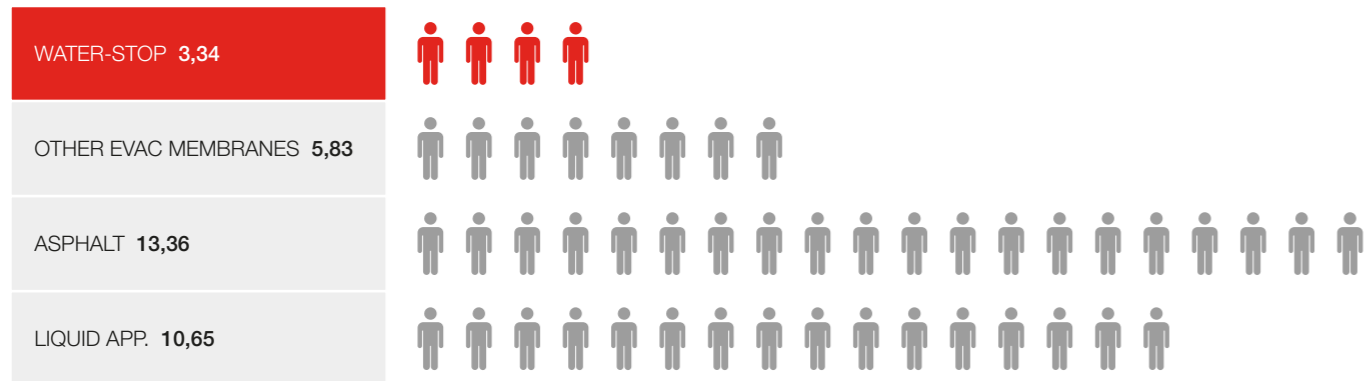

### 3. INSTALLATION TIME: AVERAGE INSTALLATION TIME / M<sup>2</sup>

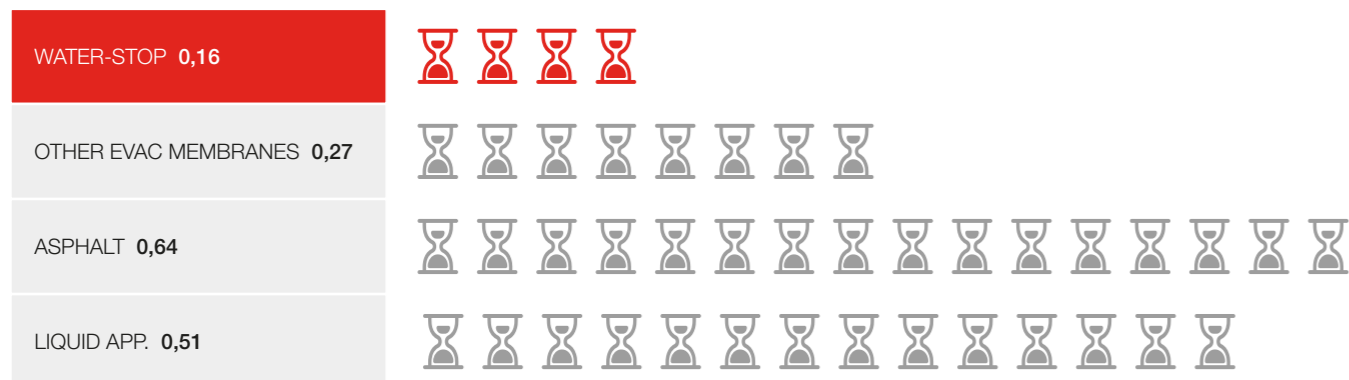

\* Prices based on CYPE SPAIN

# COSTS ARE ALWAYS LOWER WITH GURU

### 4. GENERAL COST: PRODUCT PRICE + LABOUR + INSTALLATION TIME + MATERIALS USED

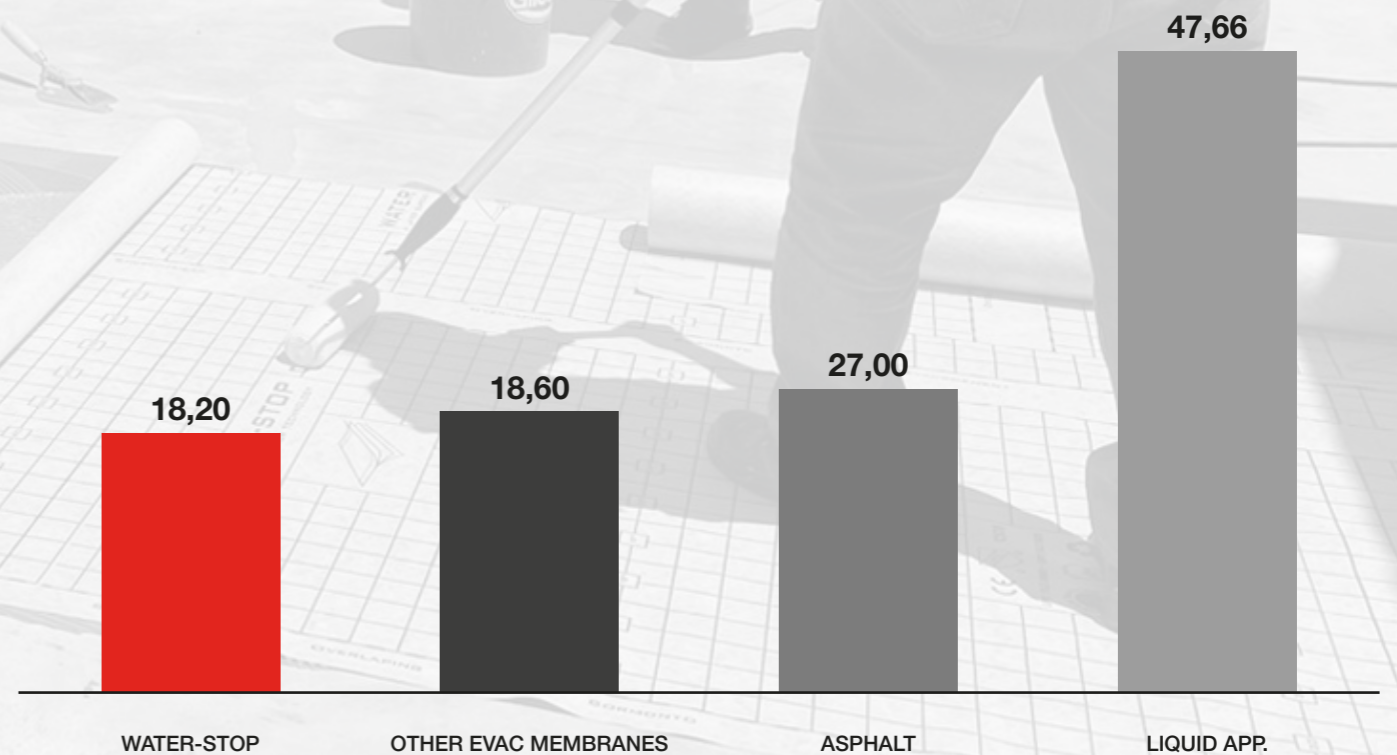



## EXAMPLE OF INDOOR INSTALLATION

Integrated showers, adapted toilets, gallery, sills, washrooms, changing rooms, kitchen, laundry... And public spaces like hospitals, hotels, care homes, schools, sports centres, fitness centres, spas...

REF.	DESCRIPTION	PERFORMANCE	PAGE	FORMAT
IF52000	WATER-STOP ROLL 1 x 30 m · 30 m <sup>2</sup>	-	12	ROLL
IGU6005	W-S DEX	-	42	BAG 2 PCS.
IGU6006	W-S DIN	-	42	BAG 2 PCS.
IG60004	W-S TUB	-	42	BAG 2 PCS.
IG64000	W-S MASTIC	6 meters	43	CAN 290 ml
IG61000	W-S BAND 14	-	42	ROLL 14 cm x 20 m
IGU6007	MIXING VALVE SEAL	-	-	BAG 1 U.

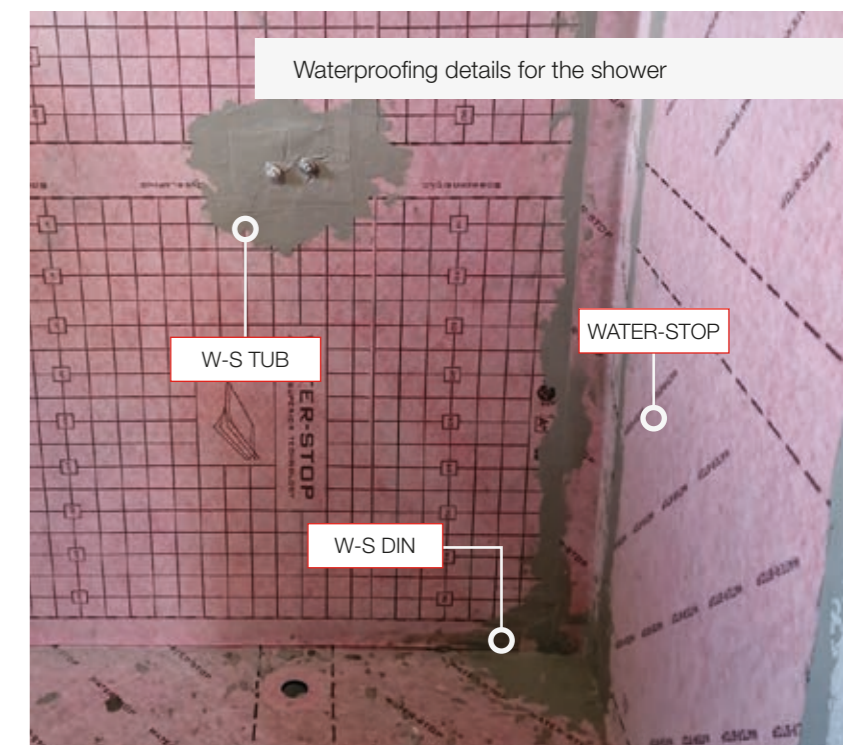
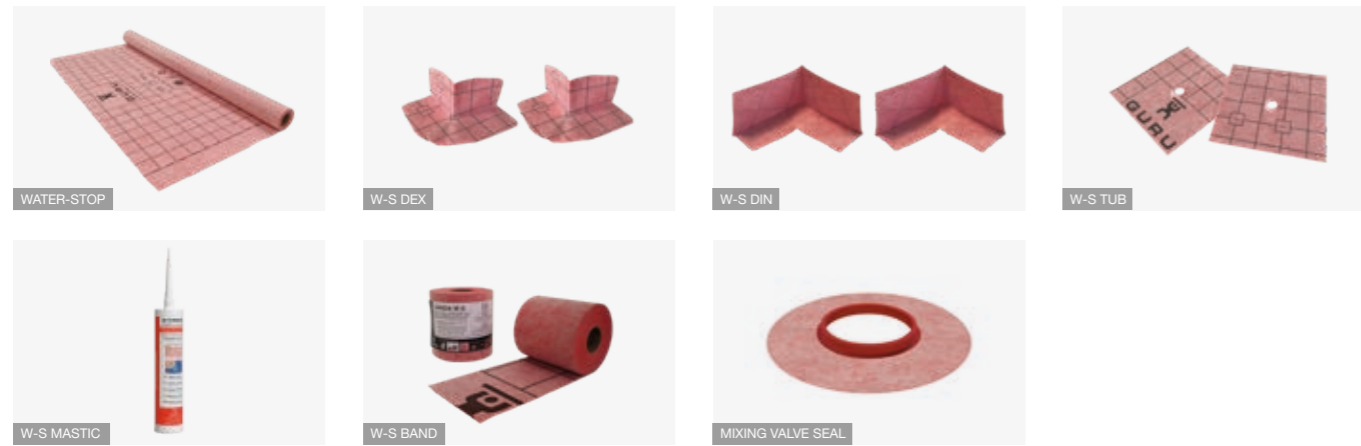

Explore our range of **complete shower kits.**

Page 56



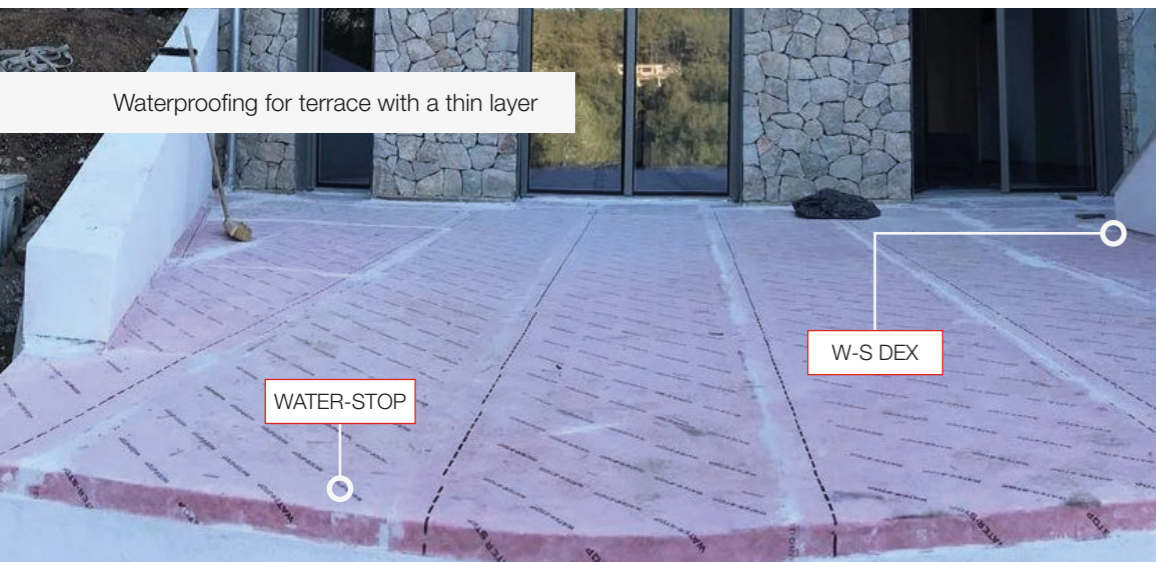

## EXAMPLE OF OUTDOOR INSTALLATION

WATER-STOP is a waterproof membrane suitable for both transitable and non-transitable terraces, making it 100% effective for outdoor use. WATER-STOP is also ideal for waterproofing roofs, both transitable and non-transitable, balconies, cisterns and tanks.

REF.	DESCRIPTION	PERFORMANCE	PAGE	FORMAT
IF53000	WATER-STOP ROLL 2 x 20 m · 40 m <sup>2</sup>	-	12	ROLL
IGU6005	W-S DEX	-	42	BAG 2 PCS.
IGU6006	W-S DIN	-	42	BAG 2 PCS.
IF56024	W-S PASSTUB 110 mm (Gargoyle) *1	-	42	1 U.
IG61000	W-S BAND 14 cm x 20 m	-	42	ROLL
IG60023	EASEAL 20 kg	325 m.l. *2	43	BAG
IG64000	W-S MASTIC 290 ml	6 m.l.	43	CAN
IG63000	W-S BUTIL 5 cm x 10 m	10 m.l.	43	ROLL

\*1 Refer to page 42 for additional measurements.

\*2 For this installation method, a 5 cm overlap is required for performance. See page 43 for further details.



WATER-STOP



W-S DEX



W-S DIN



W-S PASSTUB



W-S BAND



EASEAL



W-S MASTIC



W-S BUTIL

Explore our range of **outdoor drainage systems.**

Page 50



Waterproofing for water tanks

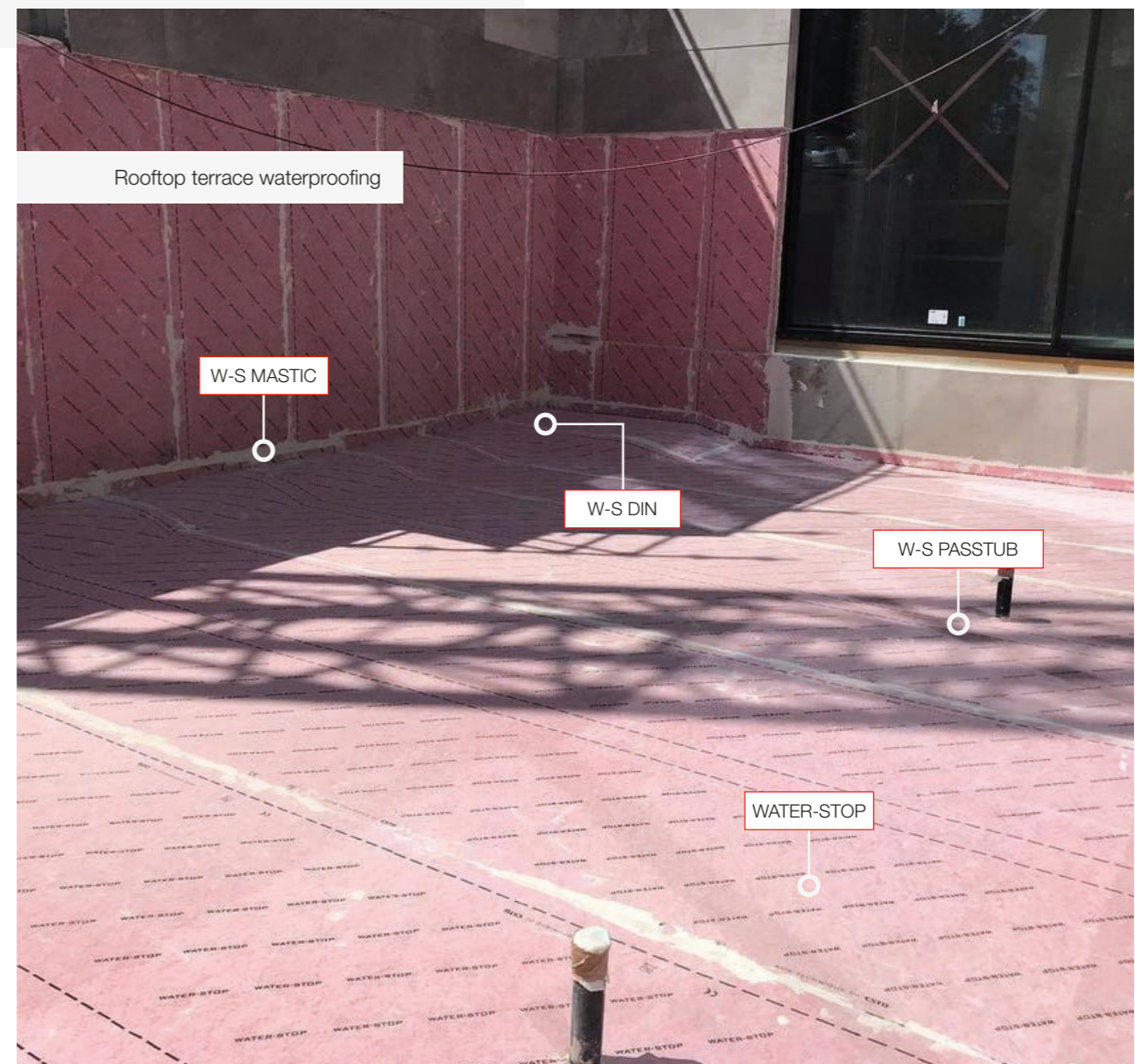

Rooftop terrace waterproofing



## EXAMPLE OF INSTALLATION IN AN OLYMPIC SWIMMING POOL

Our waterproof membrane is perfect for swimming pools. Its multi-layer composition guarantees the pool's integrity against leaks. It is worth noting that the WATER-STOP membrane can be used to bridge small cracks caused by time, wear and tear, or roots.

REF.	DESCRIPTION	PERFORMANCE	PAGE	FORMAT
IF53000	WATER-STOP ROLL 2 x 20 m · 40 m <sup>2</sup>	-	12	ROLL
IG60021	SAFETUB Ø 63-Ø 75 mm	-	42	BAG 5 PCS.
IG61000	W-S BAND 14	-	42	ROLL 14 cm x 20 m
IG60023	EASEAL 20 kg	120 m.l. *	43	BAG
IG63000	W-S BUTIL 5 cm x 10 m	10 m. l.	43	ROLL

\* Performance for this installation method overlaps with W-S BAND. See page 43 for additional information.



WATER-STOP



SAFETUB



W-S BAND



EASEAL



W-S BUTIL

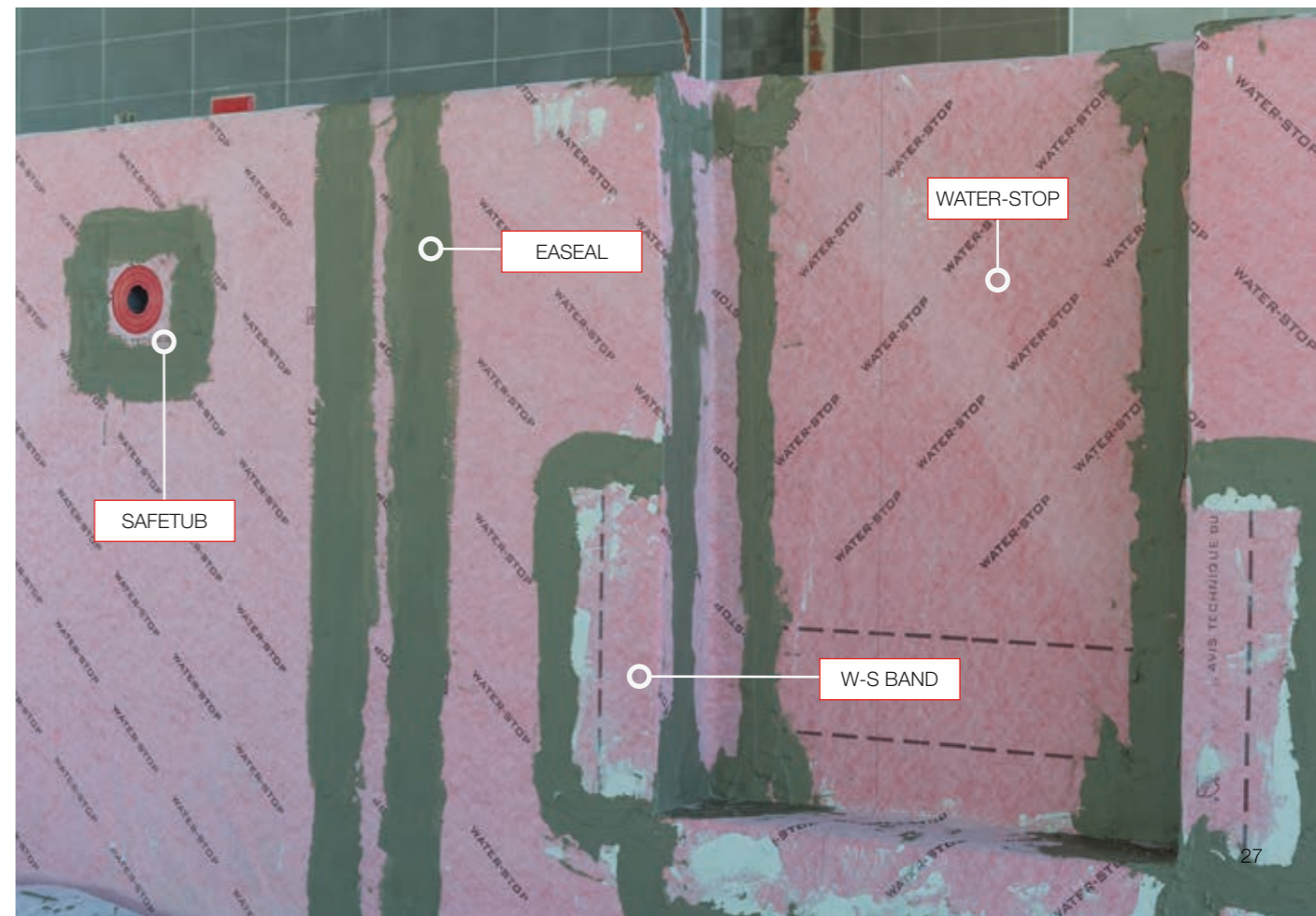



UNCOUPLING MEMBRANE **G-FLEX**



Scan the QR code and discover more

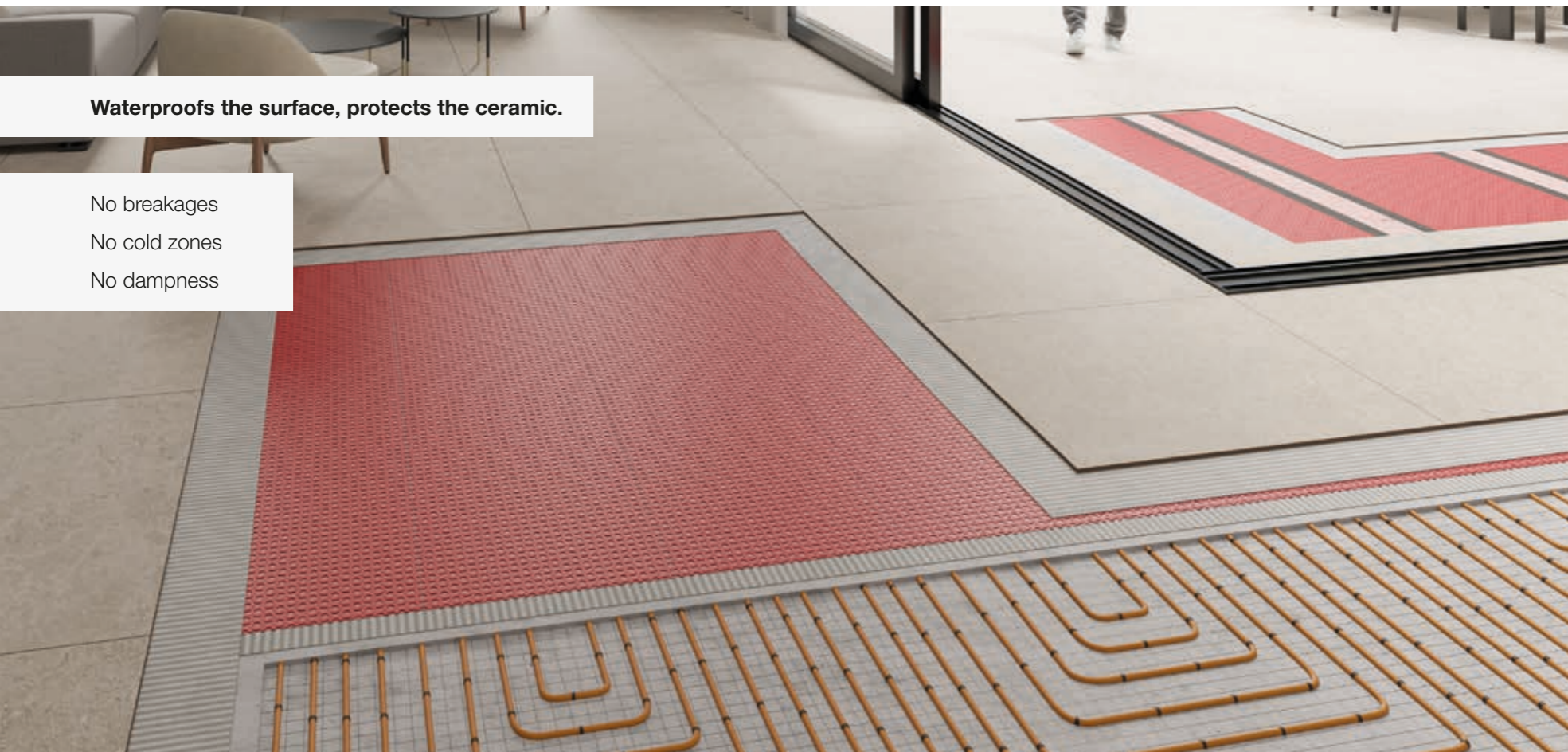

Waterproofs the surface, protects the ceramic.

- No breakages
- No cold zones
- No dampness

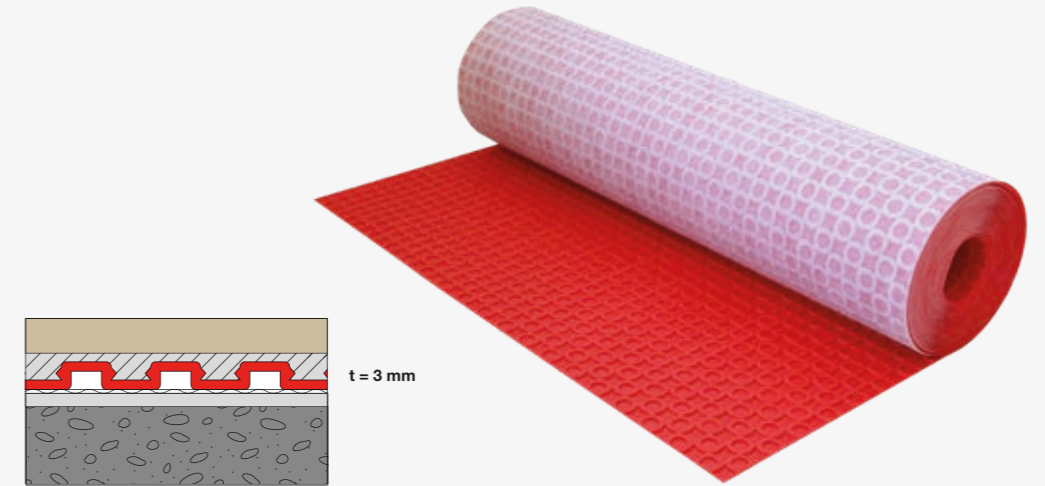

**Features**

- » Uncoupling
- » Load sharing capacity
- » Better heat distribution
- » Decoupling
- » Vapour and moisture management
- » Waterproofing

**Specifications**

- » Weight/m<sup>2</sup> (gr): 550
- » Width (m): 1
- » Length (m): 14, 30
- » NAIL - Mechanical anchor
- » Adherencia: 75 tons/m<sup>2</sup>
- » Robinson Floor Test - Extra Heavy

G-FLEX is a **waterproof and anti-fracture uncoupling membrane**. G-FLEX membrane waterproofs and protects any surface, old or new, wet or dry, cracked or subject to dimensional movement.

Furthermore, it **reduces on-site installation time** as the cladding can be installed and laid **without any waiting period**. This means that **the installation can be walked on immediately**. It also plays a crucial role in **underfloor heating** installations due to its ducts that distribute heat evenly across the entire surface.

Due to G-FLEX's effectiveness in moisture release from the slab in new constructions, there is a significant reduction in waiting time for ceramic installation, completing it in less than 28 days, resulting in a savings of up to two weeks in the construction process. This same moisture **dissipation capability** makes it ideal for renovations in areas prone to rain, even on previously damp surfaces.

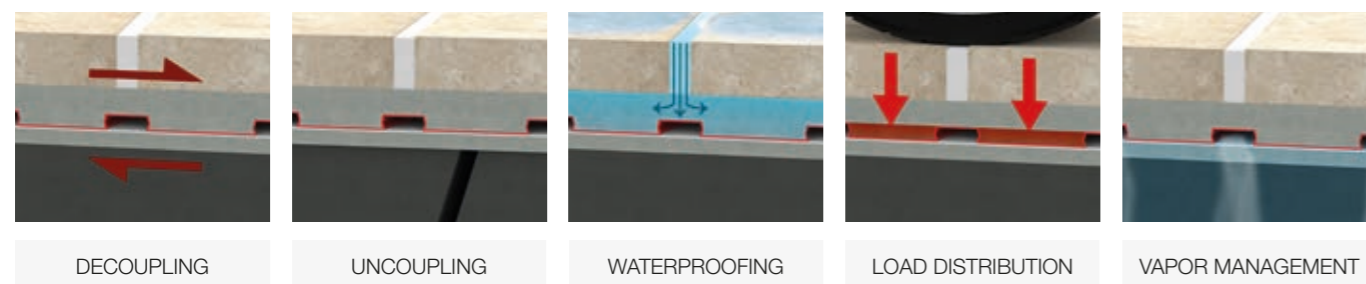
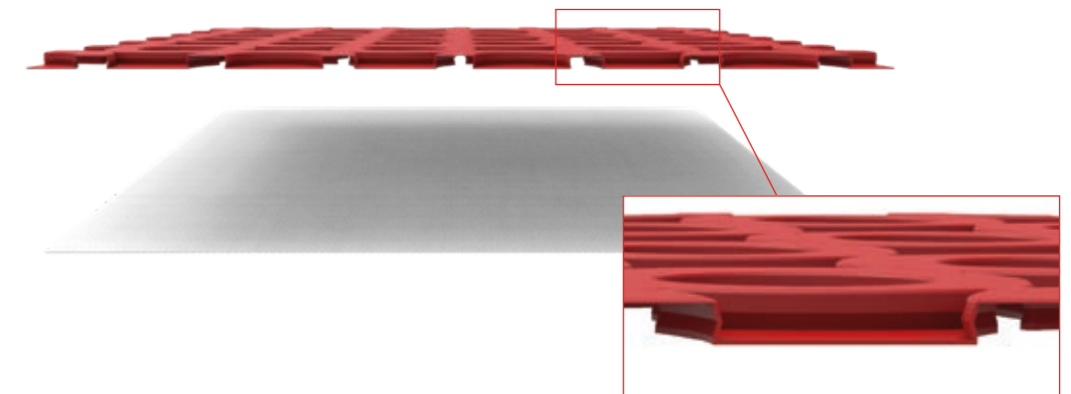

PRODUCT			LOGÍSTICA	
REF.	DESCRIPTION	MEASURE	PCS/BOX	PCS/PALLET
ILU5100	G-FLEX ROLL	1 x 14 m · 14 m <sup>2</sup>	1	12
ILU5200	G-FLEX ROLL	1 x 30 m · 30 m <sup>2</sup>	1	20



## MAXIMUM PROTECTION, ZERO BREAKAGE

The G-FLEX membrane is notable for its ability to **distribute loads**, which helps to protect cladding on large surfaces like terraces, squares, or high-traffic areas such as car parks or car dealerships.

This advantage is even greater for **large-format, thin ceramic** installations.



## EXAMPLE OF OUTDOOR AND INDOOR INSTALLATION

The G-FLEX membrane is suitable for use both indoors and outdoors. The tiling is protected by its ability to adapt to the movements of the subfloor, which evenly distributes heavy loads over the entire surface and prevents the ceramic from being affected by contraction or expansion. An ideal option for safeguarding ceramics, particularly those with small thicknesses and large formats.

Furthermore, its waterproof property provides an extra layer of protection against potential leaks or dampness, guaranteeing the longevity and integrity of your surfaces.

Thanks to the effectiveness of G-Flex in releasing and dissipating moisture from the floor slab in new construction, we can install in areas with high rainfall, even on previously damp surfaces, without having to wait for them to dry out.

REF.	DESCRIPTION	PERFORMANCE	PAGE	FORMAT
ILU5200	G-FLEX ROLL 1 x 30 m · 30 m <sup>2</sup>	-	29	ROLL
IG61000	W-S BAND 14	-	42	ROLL 14 cm x 20 m
IG60023	EASEAL 20 kg	50 m.l.	43	BAG



G-FLEX



W-S BAND



EASEAL

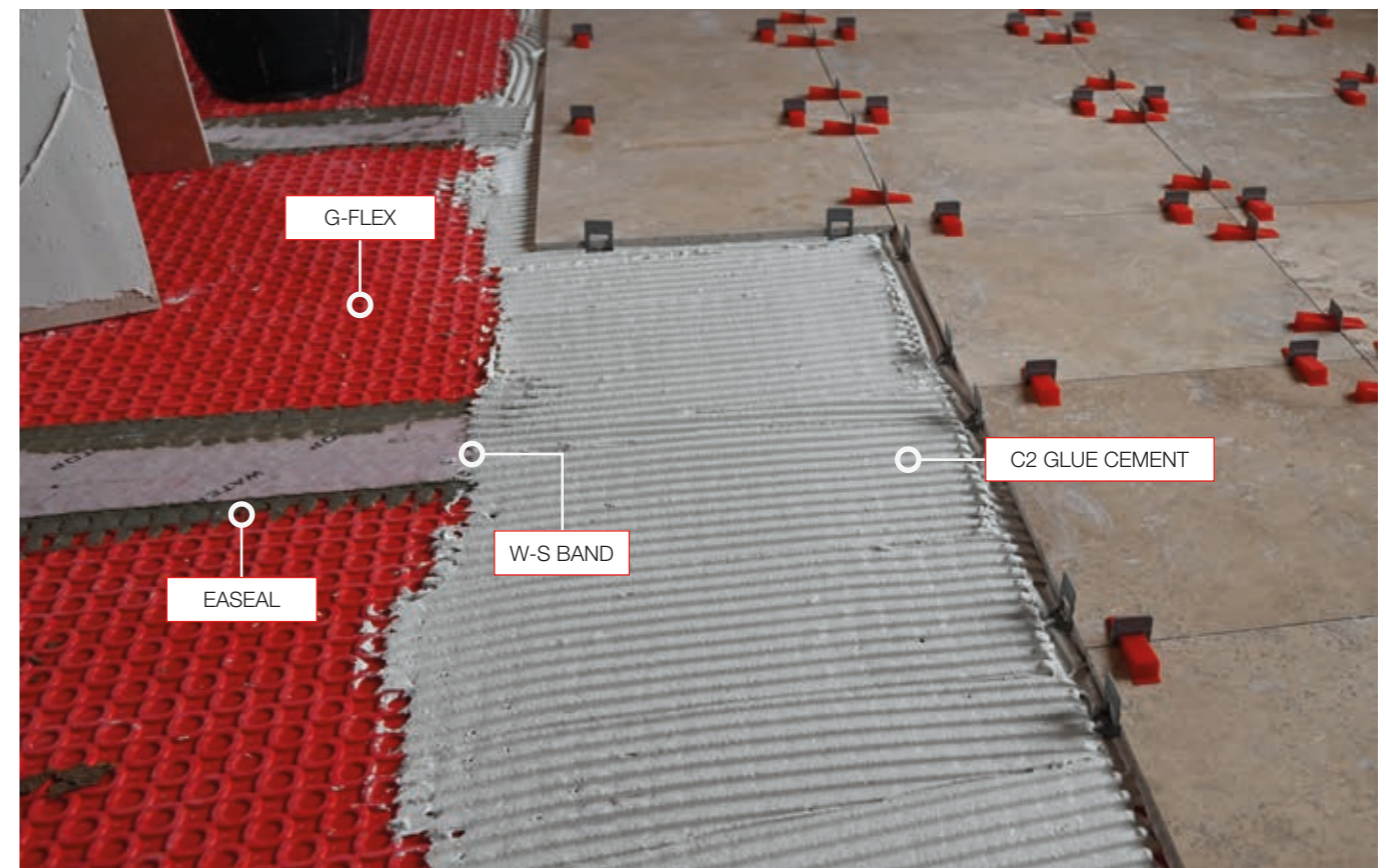



## INSTALLATION AGAINST NEGATIVE PRESSURE AND CAPILLARITY MOISTURE

Negative pressure moisture can be defined as the ability of water to infiltrate from the exterior of the house to the interior, potentially causing defects in the wall, the appearance of molds, unpleasant odors, and material detachment.

This type of problem often occurs in underground constructions, specifically in walls adjacent to embankments, garages, basements, or moisture rising by capillarity from the subsoil due to a high water table.

G-FLEX is a very useful solution to combat negative pressure moisture, as the space created between the waterproof membrane and the ground or wall allows moisture to escape from the construction, dissipating into the air and not affecting the structure.



REF.	DESCRIPTION	FORMAT
IG68000	G-WASHER (250 UNITS)	BOX



The use of screws 5/6 mm thick and suitable wall plugs for the type of wall is recommended.

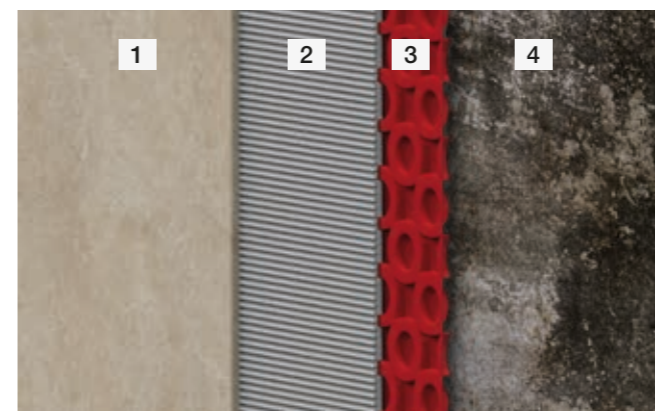

**Negative humidity with ceramic finish**

- 1- Ceramics. 2- C2 Cement Glue.
- 3- G-FLEX. 4- Wet wall.

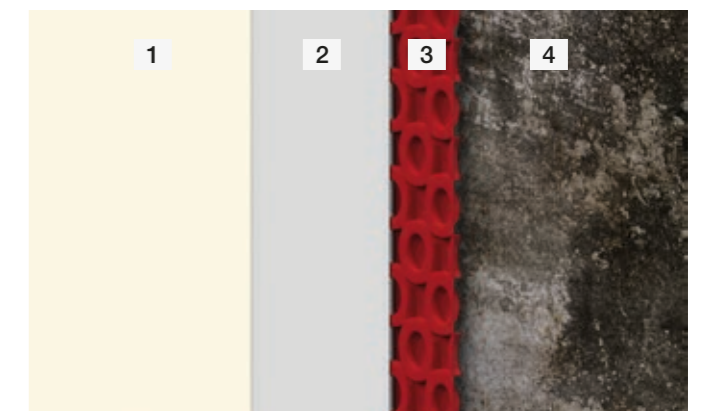

**Negative moisture plastered and painted**

- 1- Painted wall. 2- Plaster.
- 3- G-FLEX. 4- Wet wall.



**IMPACT MEMBRANE G-SOUND**



Scan the QR code and discover more

**G-SOUND: The tranquillity of silence**

IDEAL FOR RENOVATIONS

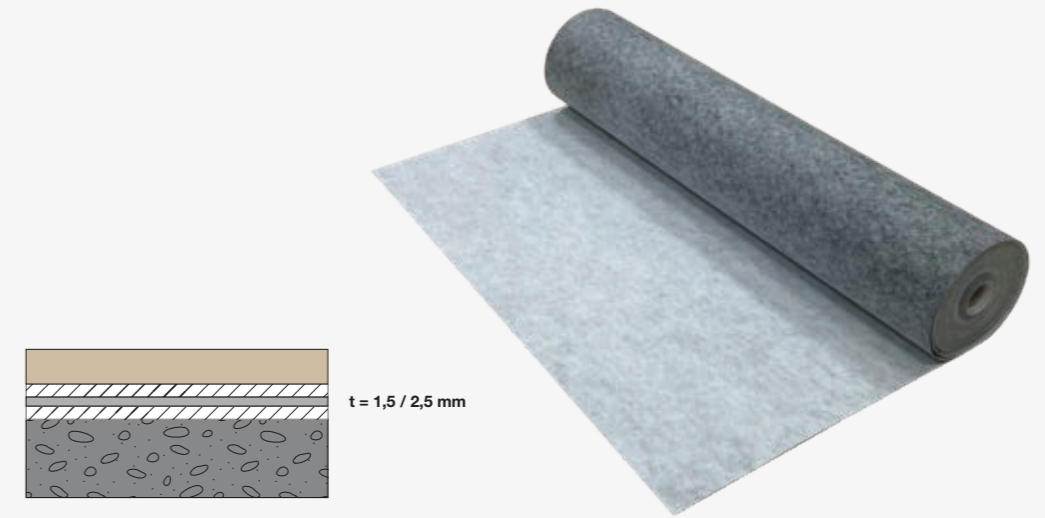

**Features**

- » Minimum installation thickness: 3,5 mm with C2 - 1,5 / 2,5 mm membrane (depending on the model)
- » It can be used for waterproofing and decoupling
- » Easy to work with, flexible and manoeuvrable
- » Higher compressive strength than the materials currently available
- » Balancing lightness and accessibility
- » Multifformat and multiproduct ceramic: it can be used with various types of cladding, paving, or natural stone

**Specifications**

- » Total weight: 440 gr/m<sup>2</sup> (G-SOUND) and 590 gr/m<sup>2</sup> (G-SOUND PREMIUM)
- » Total product thickness: 3 mm
- » Made from recycled products
- » Noise reduction and complete waterproofing

G-SOUND is a range of innovative products that effectively **reduce the impact noise levels** by 14 dB to 21 dB, while also saving space. A thick mortar bed is not needed for this bonded membrane. The **total thickness required for installation is less than 1 cm.**

G-SOUND not only reduces noise but also excels in **renovation projects** and **includes waterproofing** features. This dual functionality provides protection against both disturbing noise and **moisture.**

Improve your spaces with G-SOUND impact membrane and enjoy the peace of mind you deserve.



PRODUCT			LOGISTICS	
REF.	DESCRIPTION	MEASURE	PCS/BOX	PCS/PALLET
IU70000	G-SOUND ROLL	1 x 30 m · 30 m <sup>2</sup>	1	60
IU70100	G-SOUND PREMIUM ROLL	1 x 30 m · 30 m <sup>2</sup>	1	60



**IMPACT MEMBRANE G-SOUND**

Tests carried out:

Sound reduction index in accordance with UNE-EN ISO 10140-3:2022 and UNE EN ISO 10140-1:2022 (Annex H)  
Laboratory measurement of impact noise reduction transmitted by floor coverings on standardized heavy floor

**Description of the installation for the test, specimen, and test arrangement:**

Reference floor: Concrete slab with a thickness of 150 mm  
Sample: Multilayer PP/PES soundproofing membrane 'G-Sound 440' with a thickness of 3 mm and a density of 173 Kg/m<sup>3</sup> under a 50 mm thick concrete slab with a density of 1670 Kg/m<sup>3</sup>.

Air temperature in the emitting chamber. 22,0 °C      Volume of the receiving chamber. 63 m<sup>3</sup>  
Percentage of air in the emitting chamber. 47,7 %      Drying time. 144 hours

Frequency f (Hz)	Ln,0 (One-third octave) dB	ΔL (One-third octave) dB.
50		
63		
80		
100	63,5	-4,2
125	62,8	-0,7
160	63,6	-0,8
200	63,4	-2,0
250	62,3	-1,0
315	62,7	2,0
400	66,5	5,7
500	66,9	5,7
630	68,9	8,5
800	70,4	10,0
1000	70,6	13,8
1250	70,4	15,7
1600	71,3	18,9
2000	71,5	21,2
2500	71,9	24,6
3150	71,7	27,6
4000	71,2	31,2
5000	70,3	33,7

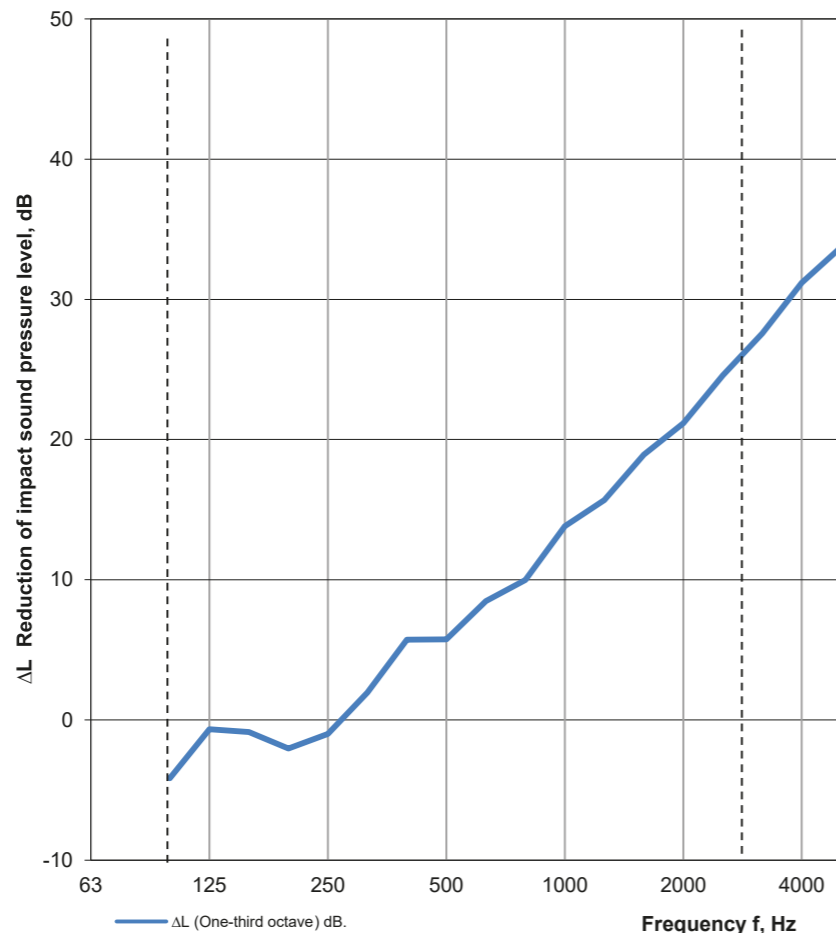

Assessment according to the international standard ISO 717-2

ΔL<sub>w</sub> = 15 dB

C<sub>i,A</sub> = -10 dB  
C<sub>i,r</sub> = -1 dB

These results are based on tests conducted with an artificial source under laboratory conditions (engineering method).

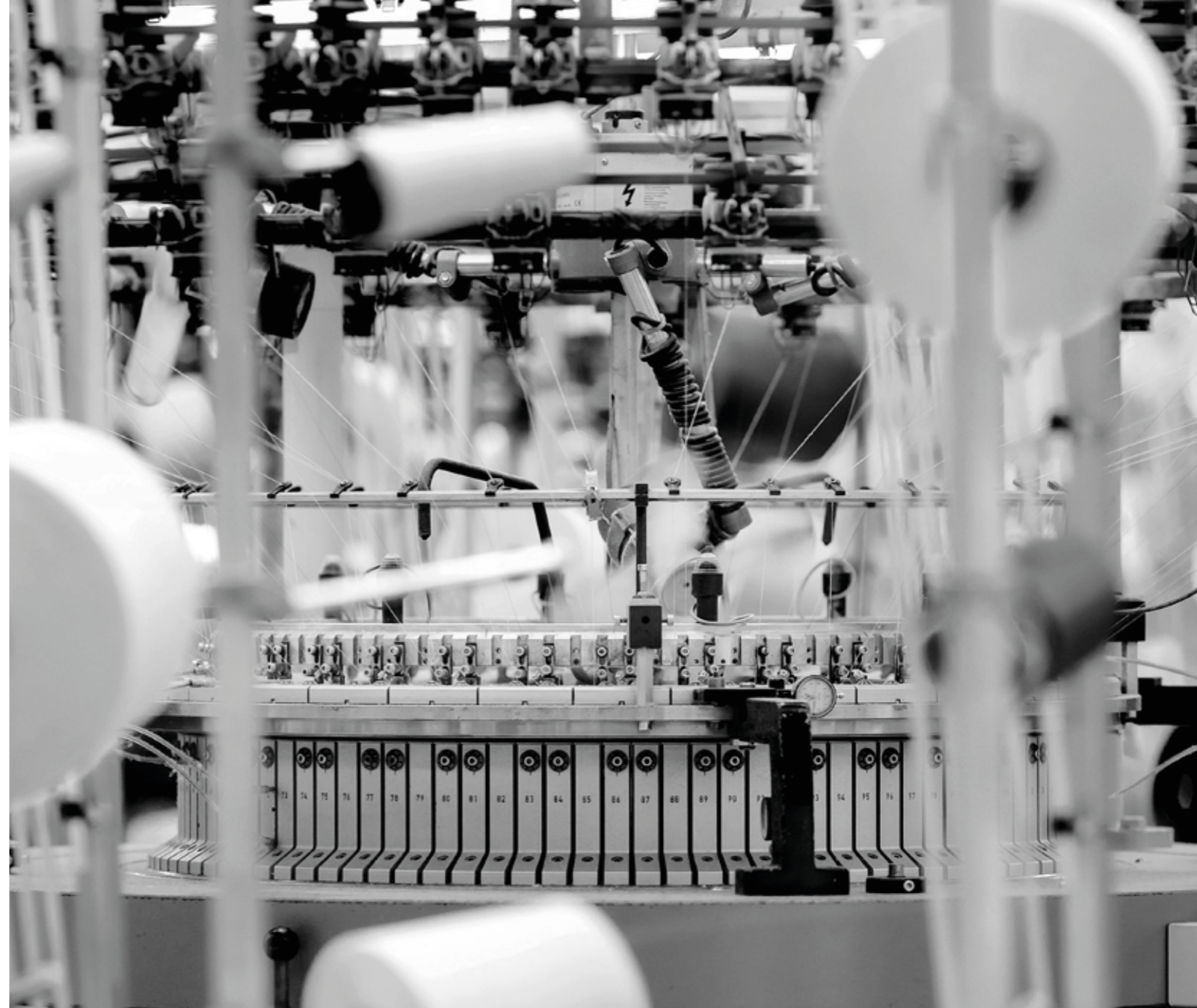

The G-SOUND impact sheet has been designed to provide an impenetrable defense against noise resulting from impacts. To achieve this, G-SOUND has not only passed but has far exceeded all the rigorous tests to which it has been subjected.

We have conducted exhaustive tests using the Sound Reduction Index, in accordance with the strict UNE-EN ISO 10140-3:2022 and UNE EN ISO 10140-1:2022 standards. The results are more than promising: G-SOUND has demonstrated its exceptional ability to absorb and dissipate impact noise, rising well above the standards.

The tests precisely measured the reduction of impact noise transmitted through floor coverings on typically heavy floors. The superior performance of G-SOUND not only complies with the most demanding regulations but redefines them.

It is worth noting that the assessment of results has been carried out according to the international ISO 717-2 standard and is based on tests under laboratory conditions (engineering method).



## BREATHABLE MEMBRANE W-S AIR

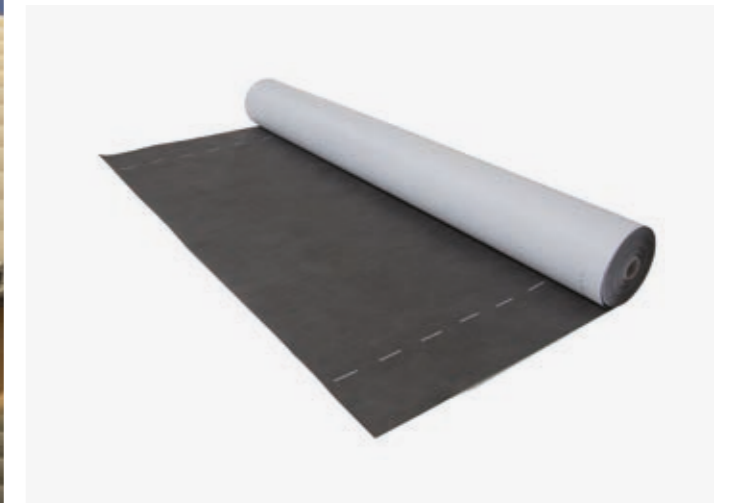

It is a membrane that is impermeable to liquid water but allows water vapour to pass through. This membrane is used for vapour control on sloping roofs and ventilated façades. It should be installed under the protection and on the load-bearing structure, resting on the beams or on the deck (concrete slab, wood, panels...) or directly on the thermal insulation.

### Features

- » Totally watertight
- » High vapour permeability
- » Simple installation (overlap marking)
- » Protection of the structure from the effects of moisture
- » Prevents heat loss through convection and condensation

### Specifications

- » Microporous film
- » Thickness: 0,4 mm
- » Non-woven veil on both sides

PRODUCT			LOGISTICS	
REF.	DESCRIPTION	MEASURE	PCS/BOX	PCS/PALLET
IH70001	W-S AIR	1,5 x 50 m	3	40



• Reinforcements for critical points



**W-S TUB**  
Pipe reinforcement. Ø18- Ø 22 mm

**W-S DEX**  
Outer corner strengthener 90°

**W-S DIN**  
Inner corner strengthener 90°.

REF.	DESCRIPTION	FORMAT
IG60004	W-S TUB	Bag 2 pcs.
IGU6005	W-S DEX	Bag 2 pcs.
IGU6006	W-S DIN	Bag 2 pcs.

• Joining elements



**W-S BAND 14 / 34**  
Reinforcement and termination at joints with vertical parameters and joints of joinings.

**SAFETUB**  
Adaptable pipe reinforcement. Used for pipes, single-lever mixers, roof ventilating chimneys etc.

**W-S PASSTUB**  
Pipe reinforcement. Customisable based on the pipe diameter for waterproofing.

REF.	DESCRIPTION	MEASURE	FORMAT
IG61000	W-S BAND 14	14 cm x 20 m	Roll
IG62000	W-S BAND 34	34 cm x 20 m	Roll
IG60020	SAFETUB	Ø 32-Ø 50	Bag 5 pcs.
IG60021	SAFETUB	Ø 63-Ø 75	Bag 5 pcs.
IG60022	SAFETUB	Ø 90-Ø 128	Bag 5 pcs.
IF56021	W-S PASSTUB	50 mm	Bag 1 pc.
IF56022	W-S PASSTUB	75 mm	Bag 1 pc.
IF56023	W-S PASSTUB	90 mm	Bag 1 pc.
IF56024	W-S PASSTUB	110 mm	Bag 1 pc.

• Tools



**G-TROWEL 3** General purpose WATER-STOP membrane. Ideal for mosaics.  
**G-TROWEL 4.5** General purpose WATER-STOP membrane. Ideal for large formats.  
**G-TROWEL 6** General purpose with G-FLEX membrane.

**W-SPATULA**  
General use WATER-STOP sheet. Used to expel excess air during the installation of the W-S sheet.

REF.	DESCRIPTION	MEASURE	FORMAT
IG67000	G-TROWEL	3 x 3 mm (tooth)	1 piece
IG67001	G-TROWEL	4,5 x 4,5 mm (tooth)	1 piece
IG67002	G-TROWEL	6 x 6 mm (tooth)	1 piece
IG67003	W-SPATULA	-	1 piece

• Adhesives



**EASEAL**  
Single component mortar. Elastic and flexible waterproofing material.  
20 kg bag // 3 kg bucket.

**W-S BUTIL**  
Two-sided adhesive sealing tape for joints.  
Measurements: 5 x 10 m.

**W-S MASTIC**  
High-module MS polymer adhesive sealer.  
290 ml can.

REF.	DESCRIPTION	MEASURE	FORMAT	PERFORMANCE
IG60023	EASEAL	20 kg	Bag	Variable *
IG60024	EASEAL	3 kg	Bucket	Variable *
IG63000	W-S BUTIL	5 cm x 10 m	Roll	10 m
IG64000	W-S MASTIC	290 ml	Tube	6 m

\* Performances/consumption for bonding and sealing joints between sheets according to the type of joint:

Overlap of WATER-STOP membrane	± 0,16 kg/m	1 kg ≈ 16 m
WATER-STOP membrane with joint cover W-S BAND 14	± 0,22 kg/m	1 kg ≈ 6 m
G-FLEX membrane with W-S BAND 14 band	± 0,30 kg/m	1 kg ≈ 3 m



ANTI-LEAK BAND **SAFEBAND**



Scan the QR code and discover more

Say goodbye to silicone problems with **SAFEBAND!**



**Features**

- » Barrier on two different planes.
- » Elastic flexible material.
- » Fibres on both sides to improve adhesion to the substrate.
- » Extra strong fixative.
- » It has a rim height of 12 cm (rise/connection overlap).

**Specifications**

- » Grammage (gr): 250
- » Width (cm): 14
- » Length (m): 2, 3'5, 6, 30
- » Elongation: 65%

**GURU PATENTED PRODUCT**

SAFEBAND revolutionises the installation of **shower trays and bathtubs** with its multi-axial and flexible anti-leak strip. This addition ensures **tight joints with walls and floors** and serves as a superior **alternative to silicone**.

Why choose SAFEBAND? ESTIL GURU's **patented design** provides a strong hold and **double protection** against leaks, effectively addressing the issues associated with silicone, such as limited durability, mould and dampness, and the risk of leaks.

This advanced sealant **meets the strict requirements of DIN 18534** and has been thoroughly evaluated by the **independent Kiwa institute in accordance with ETAG 022:2**.

**Elements included:**



PRODUCT			LOGISTICS	
REF.	DESCRIPTION	MEASURE	PCS/BOX	PCS/PALLET
IG66016	KIT SAFEBAND	2 m x 14 cm	12	324
IG66001	KIT SAFEBAND	3,5 m x 14 cm	12	324
IG66002	KIT SAFEBAND	6 m x 14 cm	12	324
IG66003	KIT SAFEBAND	30 m x 14 cm	6	54



## BATHTUB

Ensure the safe and uncomplicated installation of bathtubs, while maximising their benefits. Thanks to SAFEBAND, waterproofing and sealing joints and connections between the bathtub, walls, and floor is made simple.

Extends the life of your installation, prevents future damage and adds the waterproof protection your bathtub needs.

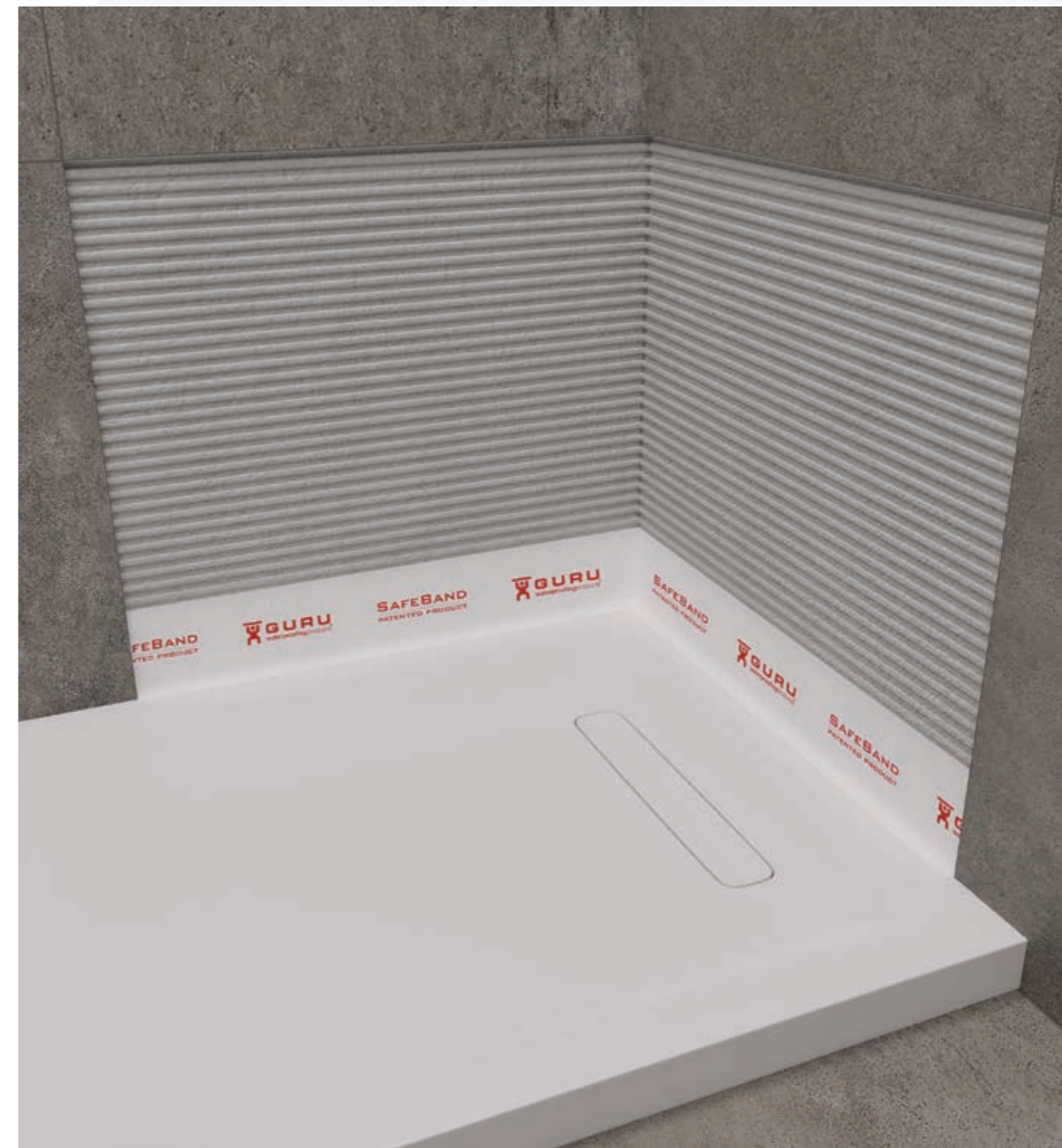

## SHOWERS

SAFEBAND is an excellent solution for installing prefabricated shower trays. It eliminates concerns about limited-service life and is very easy to apply due to its flexibility and self-adhesive nature.

It effectively prevents leaks and possible imperfections, ensuring complete waterproofing in the connections between the shower tray, walls, and floor.



BATH KIT **W-S BATHKIT**



Scan the QR code and discover more

Waterproofing for bathtub drains!



Features

- » Waterproofing included
- » High drainage capacity
- » Available in different colours
- » Easy installation

Specifications

- » Click-Clack Valve
- » Built-in Overflow
- » PVD and Textured Finishes
- » Outlet Tube Ø40 mm

The W-S BATH KIT is a **click-clack drainage** system with overflow that is specifically designed for **bathtubs**.

The system guarantees a seamless connection between the WATER-STOP waterproofing membrane and the drain, **preventing** any form of **leakage or dampness**.

W-S BATHKIT includes:

W-S BATH includes:



Click-Clack valve with a swivelling siphon.

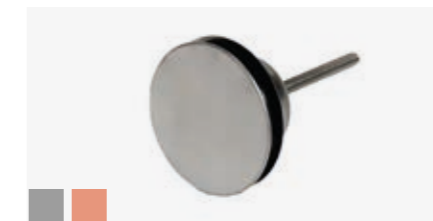

Stopper (stainless steel, black and gold finish).



Overflow.



Membrane WATER STOP 2 x 3 m.



Roll WATER STOP 1 x 5 m.



W-S MASTIC putty.

PRODUCT				LOGISTICS	
FINISHED	REF.	DESCRIPTION	W-S MEMBRANE (m)	PCS/BOX	PCS/PALLET
●	IA11000	W-S BATHKIT INOX	2 x 3 · 6 m <sup>2</sup>	4	40
●	IA11020	W-S BATHKIT GOLD	2 x 3 · 6 m <sup>2</sup>	4	40
●	IA11021	W-S BATHKIT DARK	2 x 3 · 6 m <sup>2</sup>	4	40
●	IA11022	W-S BATH INOX	-	6	94
●	IA11023	W-S BATH GOLD	-	6	94
●	IA11024	W-S BATH DARK	-	6	94



# DRAINAGE SYSTEMS FOR OUTDOOR USE

REF.	DESCRIPTION	PERFORMANCE	PAGE	FORMAT
IF53000	WATER-STOP ROLL 2 x 20 m · 40 m <sup>2</sup>	-	12	ROLL
IG61000	W-S BAND 14 cm x 20 m	-	42	ROLL
IG66003	KIT SAFE BAND 30 METERS	-	45	ROLL
IG60023	EASEAL 20 kg	333 m.l. *	43	BAG
IG64000	W-S MASTIC 290 ml	6 m.l.	43	CAN

\* Performance for this installation method. See page 43 for more details.

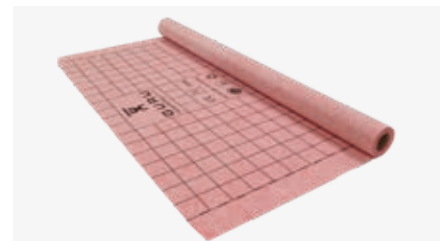

Estil Guru has developed and manufactured a range of advanced **outdoor** drainage systems specifically designed for patios, squares, terraces, or shelters, reflecting our innovative attitude.

These systems combine **efficiency and design**, elevating the standard of outdoor drainage to a new level.

Among these new options, you will find both one-time and continuous choices, allowing for adaptation to various outdoor spaces and any type of need.



MODULAR LINEAR DUCT FOR OUTDOOR USE RAYNEX



Scan the QR code and discover more

In this case, the outside does matter, AND A LOT!



RAYNEX provides an optimal external drainage solution. The **waterproofing built** into the system ensures optimal watertightness. Additionally, the **low-profile design** allows it to blend seamlessly into various outdoor spaces while maintaining high water management efficiency.

Discover the best in versatility with **customisable accessories** that meet the unique requirements of your project. Its **strength and lightness** make it capable of withstanding vehicular loads without compromising its integrity, making it an ideal choice for almost any outdoor application.

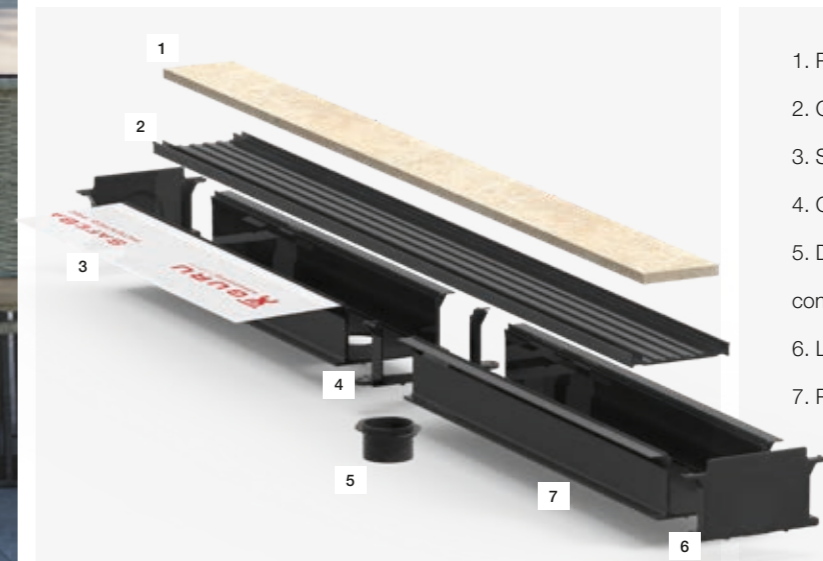

- 1. Paving
- 2. Grid
- 3. SafeBand membrane
- 4. Connecting piece
- 5. Downpipe or for lateral connection (Ø50 mm)
- 6. Lateral piece
- 7. PVC gutter

**Features**

- » Pavementable and removable grid for cleaning.
- » Adaptable to construction.
- » Material with UV protection for outdoor exposure.
- » Lightweight yet sturdy material, certified.
- » High drainage capacity.
- » Integrated low-weight waterproofing in the channel.
- » Supports vehicular traffic up to 3 tons.

**Specifications**

- » EN1433
- » Class A15 for light traffic
- » Open area: 6000 mm<sup>2</sup>/meter
- » Installation height: 60 mm + pavement

PRODUCT			LOGISTICS	
REF.	DESCRIPTION	MEASURE	PCS/BOX	PCS/PALLET
IX45100	CHANNEL AND GRATE RAYNEX DOUBLE SLOT	1 m *	1	120
IX45200	CHANNEL AND GRATE RAYNEX DOUBLE SLOT	2 m *	1	-
IX10000	JOINT	-	200	-
IX10001	SIDE COVER	-	200	-
IX10002	PIPE DIAMETER 50 mm	-	200	-
IX10003	ANGLE 90° RAYNEX	-	4	108
IG66016	SAFE BAND	2 m	12	324
IG66002	SAFE BAND	6 m	12	324

\* For large projects, the length of the channel can be customized up to 3 meters.



## OUTDOOR DRAIN KIT TERRACE

The terrace kit is a solution to complete the waterproof protection on terraces and balconies thanks to the heat-welded cup with the WATER-STOP membrane.

It consists of a PVC bowl with the specified outlet, the heat-welded membrane and a trap body with a PVC grille.

25 mm trap drain with hydraulic closure. Horizontal or vertical output.

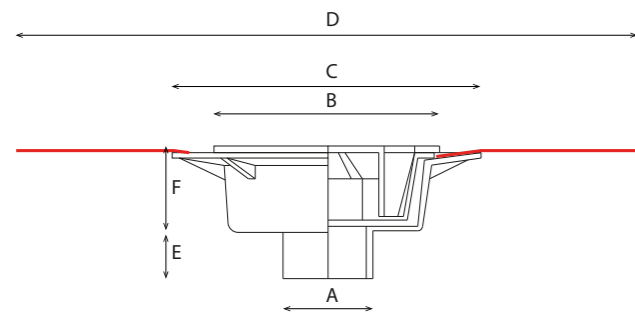
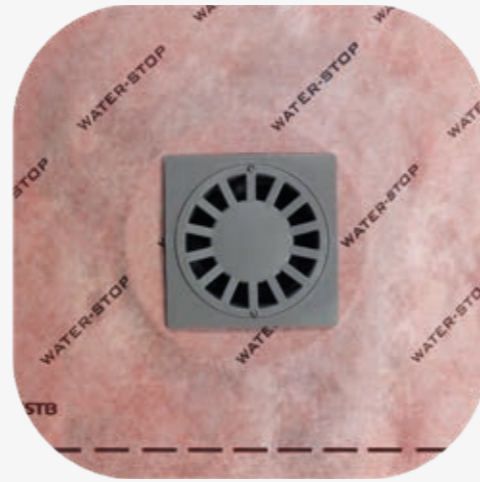

measurements in mm

A = 90 or 110	D = 600
B = 200	E = 50
C = 290	F = 92

PRODUCT			LOGISTICS
REF.	DESCRIPTION	OUTPUT	PCS/BOX
IE46000	KIT TERRACE V90	VERTICAL DN/DE 90	6
IE46001	KIT TERRACE V110	VERTICAL DN/DE 110	6

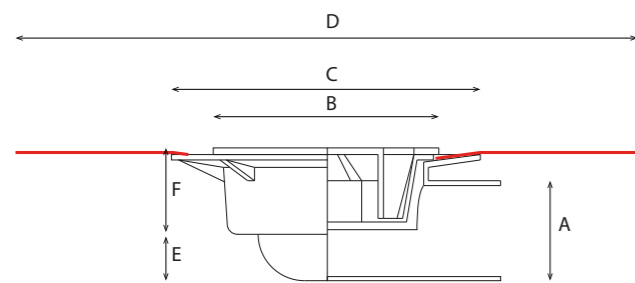

measurements in mm

A = 90 or 110	D = 600
B = 200	E = 42
C = 290	F = 92

PRODUCT			LOGISTICS
REF.	DESCRIPTION	OUTPUT	PCS/BOX
IE46002	KIT TERRACE H90	HORIZONTAL DN/DE 90	6
IE46003	KIT TERRACE H110	HORIZONTAL DN/DE 110	6

## OUTDOOR DRAIN KIT TERRACE

This product is notable for its precise manufacturing process using **high-quality** materials that are specifically designed to withstand **corrosion, weathering, and temperature changes**. By meeting the most rigorous **quality standards**, this product guarantees **exceptional durability** and optimal performance over time. The innovative design facilitates installation, providing an efficient solution for both professional and non-specialist users.

This product is characterised by its **simplicity** and **efficiency** in installation. Each component has undergone thorough quality testing to ensure structural integrity and optimal performance in various environmental conditions. In addition to its excellent quality, this product is also affordable, striking a **perfect balance** between **durability, performance, and price competitiveness**.

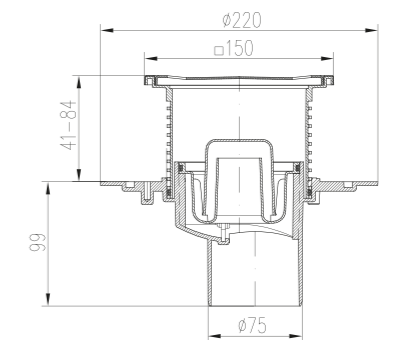
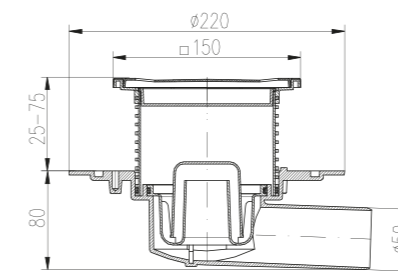

PRODUCT					LOGISTIC
REF.	DESCRIPTION	OUTPUT	FLOW RATE (l/min)		PCS/BOX
			H.S.*	D.S.*	
IE46007	KIT TERRACE PLUS V75	VERTICAL OUTPUT DN/DE 75	45	100	6
IE46008	KIT TERRACE PLUS H50	HORIZONTAL OUTPUT DN/DE 50	45	100	6

\* H.S.: Hydraulic Siphon | D.S.: Dry Siphon



# SHOWER SYSTEMS WITH WATERPROOFING INCLUDED



Estil Guru shower systems have exclusive designs and technologies that improve drainage and facilitate waterproofing of bathrooms.

Our philosophy has always been to combine design with efficiency, creating stainless steel systems that are integrated for microcement and available in various sizes, designs, and colours.

Furthermore, all our drainage systems are equipped with waterproofing and can be selected with various drainage options to meet any requirement



Find out more  
information about our  
waterproof membranes





**DRAIN TRYPHON**

Join the new generation of drainage systems featuring removable siphons

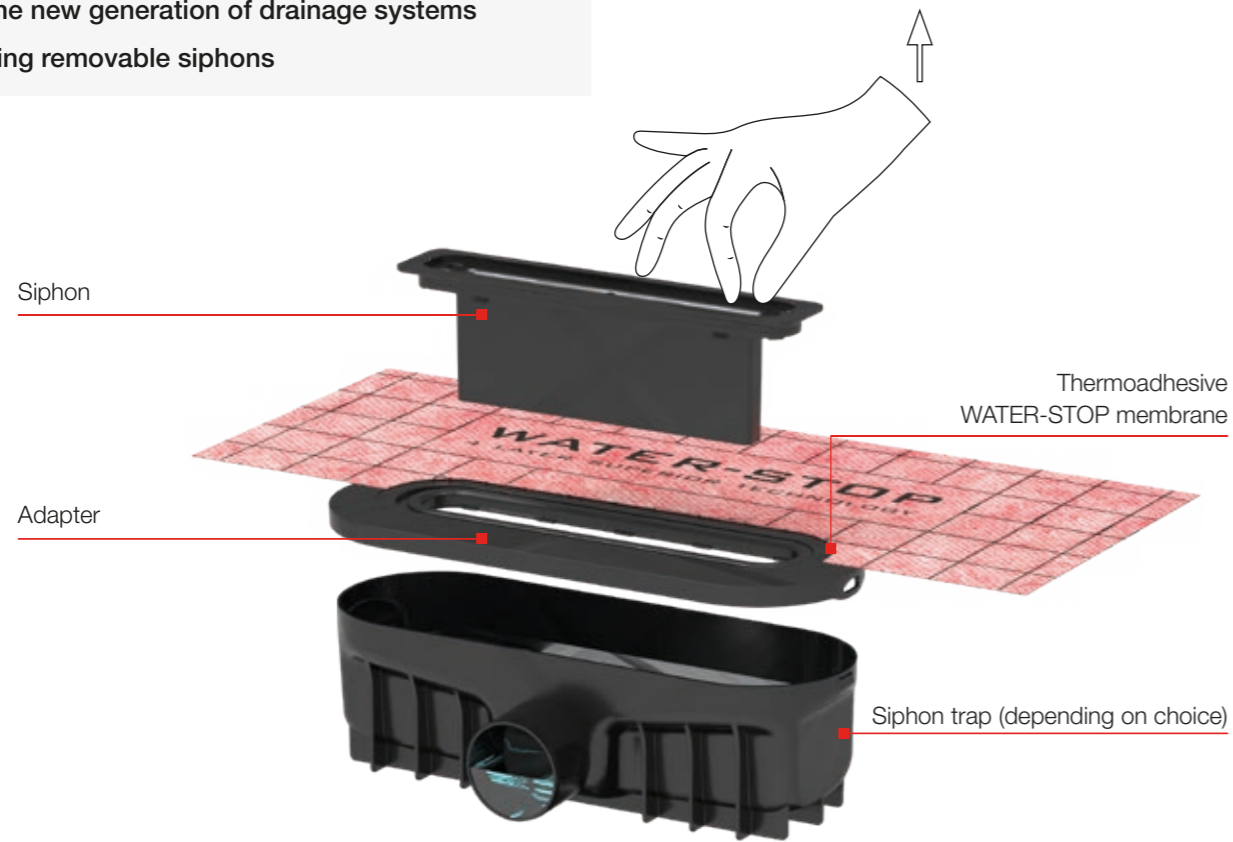

**TRYPHON DRAIN ACCESSORIES:**

REF.	DESCRIPTION
IG60031	TRYPHON REDUCED SIPHON TRAP
IG60032	TRYPHON VERTICAL SIPHON TRAP

TRYPHON is the perfect fusion of functionality and innovation. TRYPHON offers a **removable siphon** for easy cleaning and a(n) (optional) soundproofing box, revolutionising bathroom drainage.

TRYPHON provides **two siphon options - mechanical and hydraulic** - to meet specific requirements. The drain can be easily integrated into existing configurations due to its **multi-directional adjustability** and **ground-level installation**, when combined with the mechanical siphon. Furthermore, TRYPHON **incorporates factory heat-sealed waterproofing** to provide durable protection.

TRYPHON guarantees exceptional performance with an impressive evacuation flow rate ranging from 30 L/min to 68 L/min, which exceeds the standard requirement of 24 L/min. The self-cleaning function reduces the need for constant maintenance. Additionally, three outlet flow options are available: **horizontal, reduced height horizontal, and vertical**, providing installation flexibility. We emphasise the **vertical outlet** option as an innovative feature that is not commonly found in the market. This feature brings versatility and efficiency to your project.

**TRYPHON**



**Front outlet**  
Hydraulic Siphon 50 mm | Dry Siphon

**TRYPHON REDUCED**



**Reduced-height front outlet**  
Dry Siphon

**TRYPHON VERTICAL**



**Vertical outlet**  
Hydraulic Siphon 50 mm | Dry Siphon

**TRYPHON: Ø 50 mm output | Connection with pressure seal**

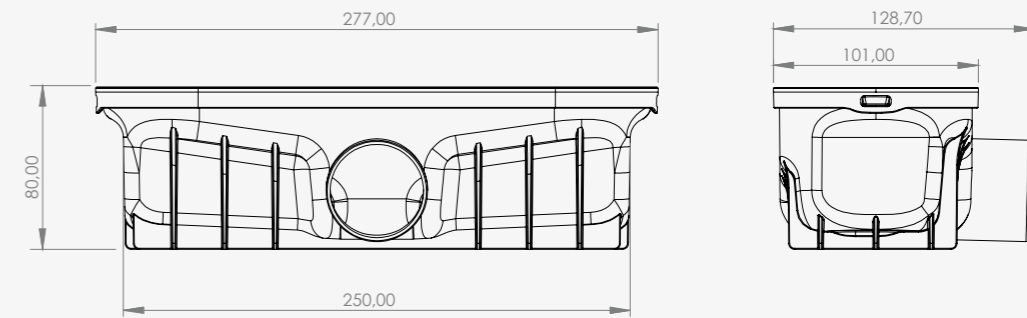

**TRYPHON REDUCED: Ø 40 mm output | Connection via gluing**

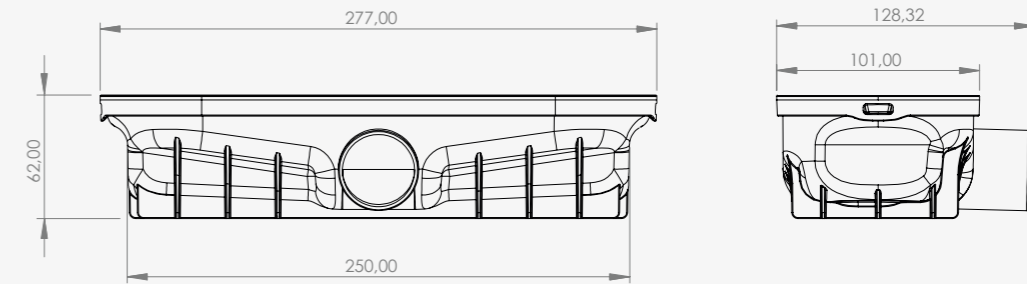

**TRYPHON VERTICAL: Ø 50 mm output | Connection with pressure seal**

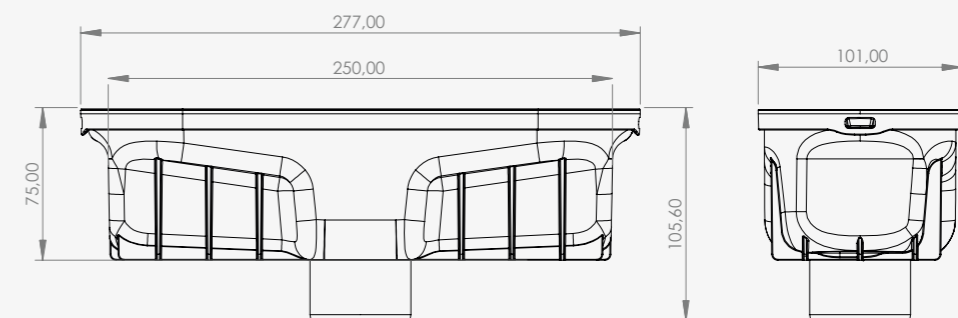





# REVOLUX

New grids **cut-outs**, 2 models, 5 finishes.



COMPLETE SHOWER KIT CUT OUT **REVOLUX TRYPHON KIT**



Scan the QR code and discover more

Measure, cut, and install!



REVOLUX is a **shower system featuring a cut-out** grating that can be tailored to fit any shower size or shape. It is notable for its **dual drainage options** and **high flow rate** of 37 litres per minute, which ensures efficient water management.

It offers **five colours and two designs** to complement the aesthetics of any bathroom. Made from **6063-T6 aluminium**, it ensures both durability and resistance to corrosion.

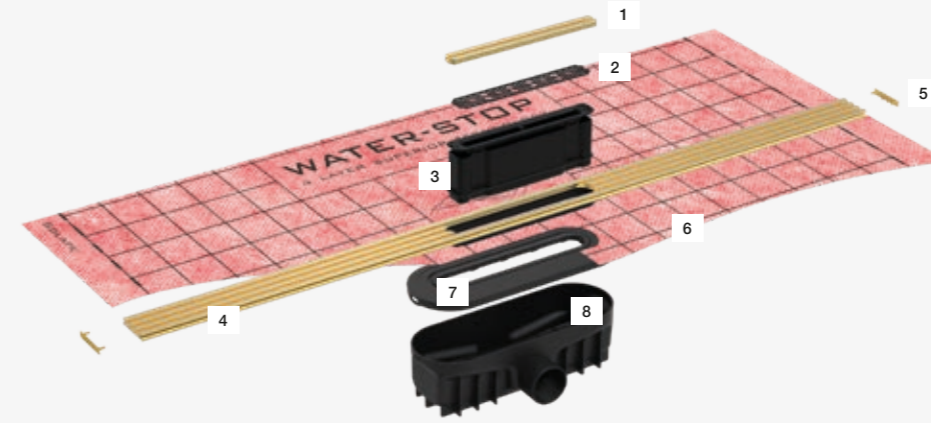

1. Trim
2. Hair collector
3. Siphon
4. Evolux grid
5. End cover
6. Water-Stop membrane
7. Adapter
8. Siphon Trap

**Features**

- » Resizable to the necessary measure
- » 2 sizes: 1 and 2 meters in length
- » We offer 2 models with 5 finishes each
- » Removable embellisher
- » Grooved with lower dovetail for better grip on support with C2 adhesive cement
- » Quick installation
- » EN1253 / DIN18534 standard

**Specifications**

- » Cargo class K3
- » Grating height: 7 mm
- » Outlet pipe: Ø50 mm
- » Installation height:
- » Aerial-grade 6063 aluminum
- » Anodized: 25 microns
- » 5 mm repositioning of grid in all directions and adjustable

TRYPHON	TRYPHON REDUCED	TRYPHON VERTICAL
88 mm	70 mm	83 mm

**The system includes**



**Optional accessory:** Tryphon Vertical Siphon Trap  
\*Check price on page. 58 (IG60032)

1- Drain of choice. 2- Grate, embellisher, and hair trap REVOLUX (model and size of choice). 3- Grate remover. 4- Mortar level cover. 5- W-S DIN x2 (inside corners). 6- W-S TUB x2 (pass-through pipes). 7- WATER-STOP membrane with thermosealed adapter (2 x 2 or 2.5 x 2.5 m). 8- Revolux Tryphon Kit box.



**COMPLETE SHOWER KIT CUT OUT REVOLUX TRYPHON KIT**

Revolux Tryphon Kit (with Tryphon Drain)

FINISHED	PRODUCT								LOGISTIC		
	TRYPHON				TRYPHON REDUCED		MODEL	MEASURE (cm)	W-S MEMBRANE (m)	PCS/ BOX	PCS/ PALLET
	REF.	FLOW RATE (l/min)		REF.	FLOW RATE (l/min)						
	H.S.*	D.S.*		D.S.*							
●	IT23004	32	49	IT23004R	49	CURVE CHROME	100	2 x 2 · 4 m <sup>2</sup>	6	40	
●	IT63004	32	49	IT63004R	49	CURVE GOLD	100	2 x 2 · 4 m <sup>2</sup>	6	40	
●	IT83004	32	49	IT83004R	49	CURVE ROSE	100	2 x 2 · 4 m <sup>2</sup>	6	40	
●	IT53004	32	49	IT53004R	49	CURVE BLACK	100	2 x 2 · 4 m <sup>2</sup>	6	40	
●	IT93004	32	49	IT93004R	49	CURVE NICKEL	100	2 x 2 · 4 m <sup>2</sup>	6	40	
●	IT24004	32	49	IT24004R	49	CAVITY CHROME	100	2 x 2 · 4 m <sup>2</sup>	6	40	
●	IT64004	32	49	IT64004R	49	CAVITY GOLD	100	2 x 2 · 4 m <sup>2</sup>	6	40	
●	IT84004	32	49	IT84004R	49	CAVITY ROSE	100	2 x 2 · 4 m <sup>2</sup>	6	40	
●	IT54004	32	49	IT54004R	49	CAVITY BLACK	100	2 x 2 · 4 m <sup>2</sup>	6	40	
●	IT94004	32	49	IT94004R	49	CAVITY NICKEL	100	2 x 2 · 4 m <sup>2</sup>	6	40	
●	IT23200	32	49	IT23200R	49	CURVE CHROME	200	2,5 x 2 · 5 m <sup>2</sup>	3	32	
●	IT63200	32	49	IT63200R	49	CURVE GOLD	200	2,5 x 2 · 5 m <sup>2</sup>	3	32	
●	IT83200	32	49	IT83200R	49	CURVE ROSE	200	2,5 x 2 · 5 m <sup>2</sup>	3	32	
●	IT53200	32	49	IT53200R	49	CURVE BLACK	200	2,5 x 2 · 5 m <sup>2</sup>	3	32	
●	IT93200	32	49	IT93200R	49	CURVE NICKEL	200	2,5 x 2 · 5 m <sup>2</sup>	3	32	
●	IT24200	32	49	IT24200R	49	CAVITY CHROME	200	2,5 x 2 · 5 m <sup>2</sup>	3	32	
●	IT64200	32	49	IT64200R	49	CAVITY GOLD	200	2,5 x 2 · 5 m <sup>2</sup>	3	32	
●	IT84200	32	49	IT84200R	49	CAVITY ROSE	200	2,5 x 2 · 5 m <sup>2</sup>	3	32	
●	IT54200	32	49	IT54200R	49	CAVITY BLACK	200	2,5 x 2 · 5 m <sup>2</sup>	3	32	
●	IT94200	32	49	IT94200R	49	CAVITY NICKEL	200	2,5 x 2 · 5 m <sup>2</sup>	3	32	

\*H.S.: Hydraulic Siphon | D.S.: Dry Siphon

**Revolux Cavity**

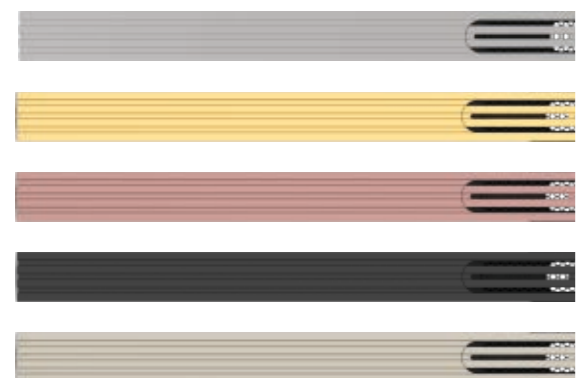

- Chrome
- Gold
- Rose
- Black
- Nickel

**Revolux Curve**

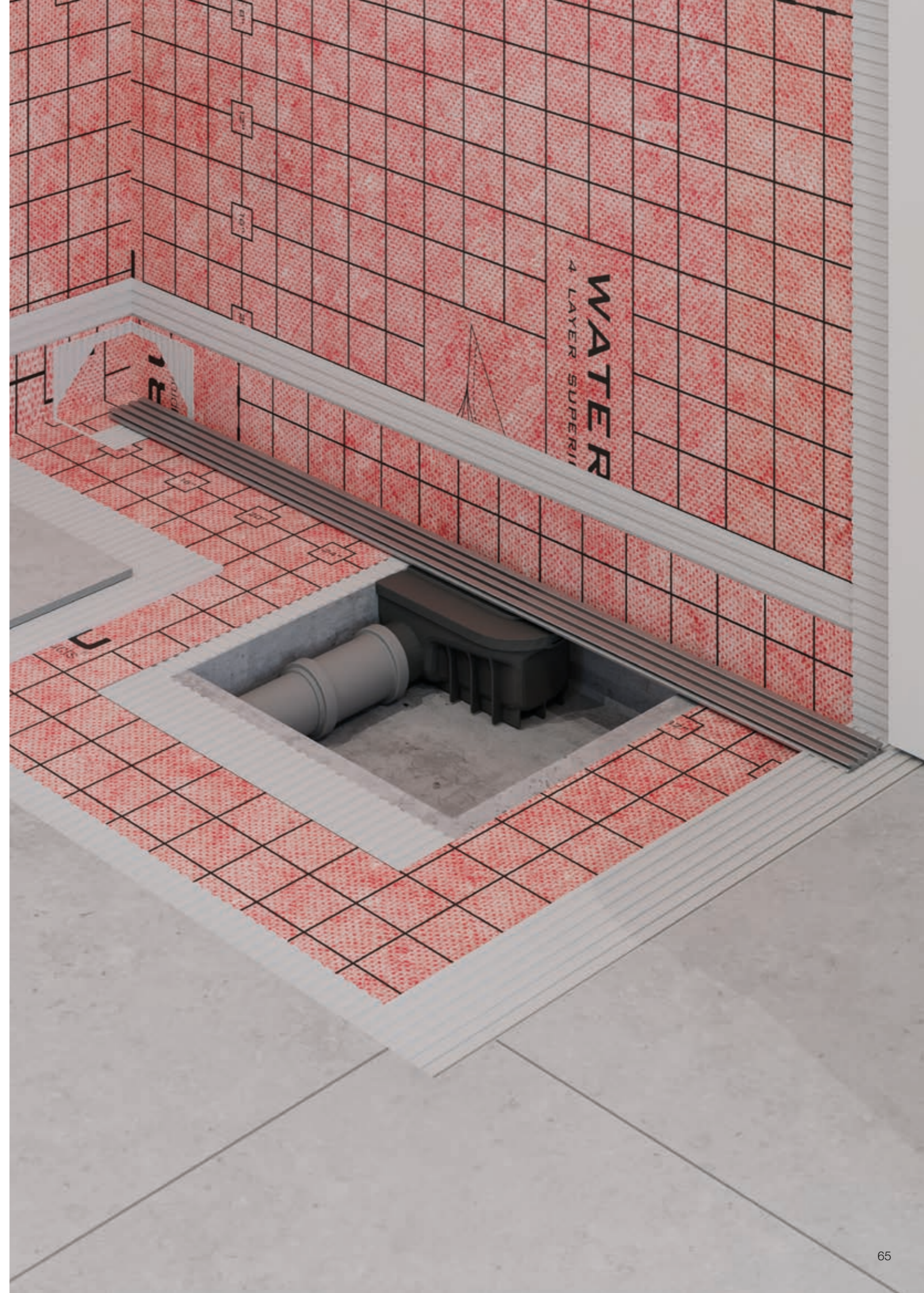
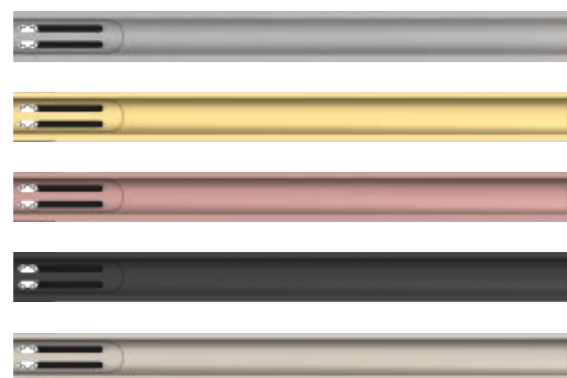



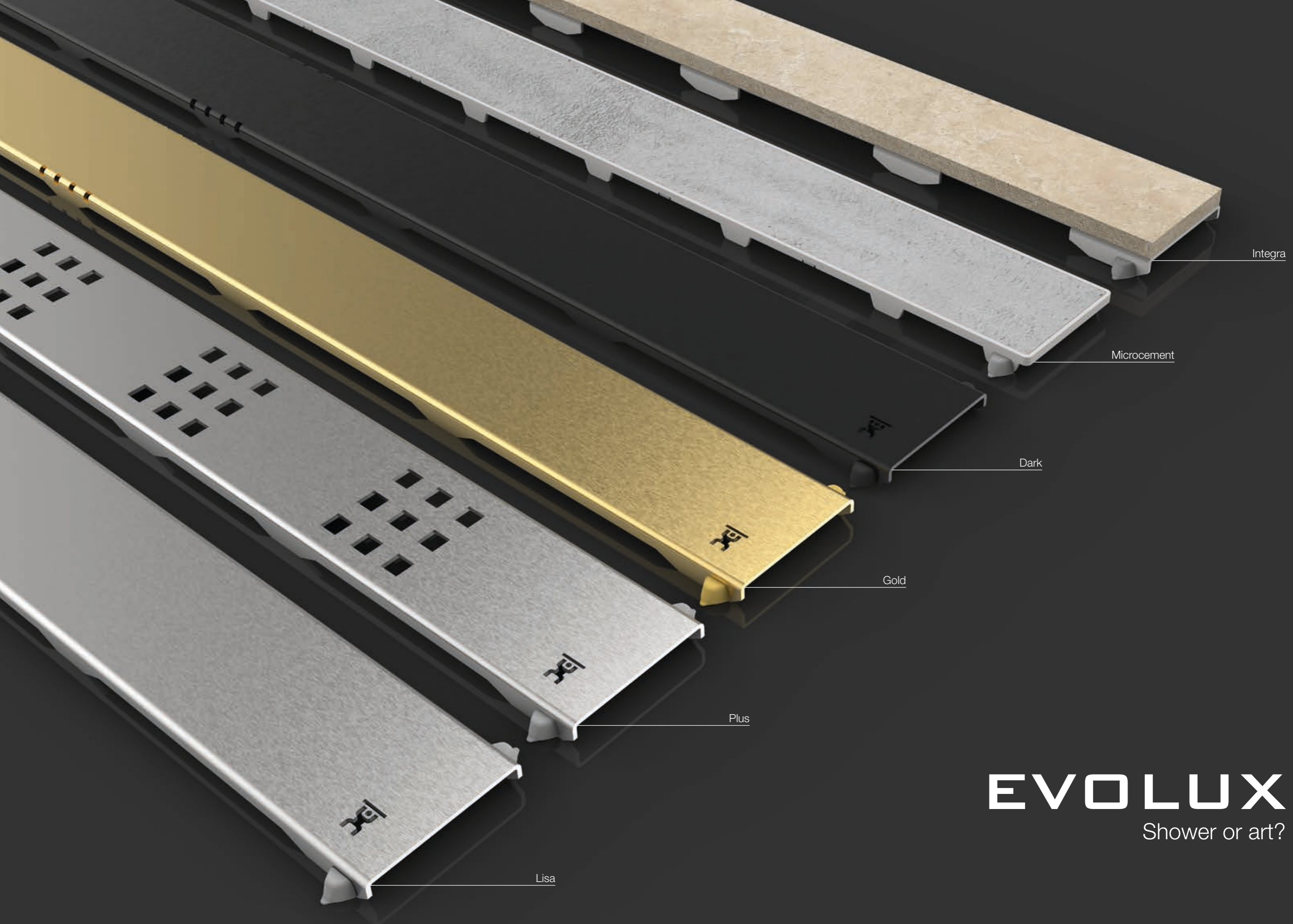

Integra

Microcement

Dark

Gold

Plus

Lisa

# EVOLUX

Shower or art?



COMPLETE SHOWER KIT **EVOLUX TRYPHON KIT**



Scan the QR code and discover more

Evolux, equal parts effectiveness and efficiency.

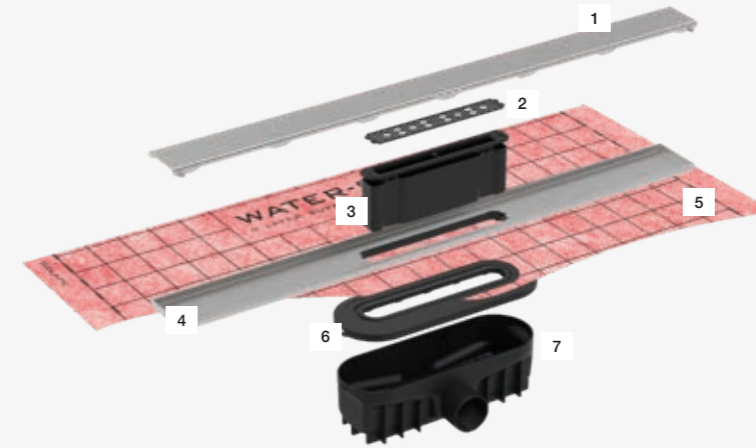



- 1. Evolux linear grille
- 2. Hair collector
- 3. Siphon
- 4. Evolux gutter
- 5. Water-Stop membrane
- 6. Adapter
- 7. Siphon Trap

**Features**

- » Infinite designs
- » Stainless steel structure
- » Resistance to high loads
- » Waterproofing included
- » High drainage capacity
- » Easy installation
- » Effective cleaning
- » 10-year warranty

**Specifications**

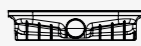
- » Stainless steel AISI 304
- » PVD and textured finishes
- » Installation height:
- » 5 mm repositioning of the grate in all directions and adjustable.

TRYPHON	TRYPHON REDUCED	TRYPHON VERTICAL
		
93 mm	74 mm	88 mm

**The system includes**



**Option 1:** Tryphon Drain

**Option 2:** Tryphon Reduced Drain

**Optional accessory:** Tryphon Vertical Siphon Trap  
\*Check price on page. 58 (IG60032)

Evolux shower system provides a **comprehensive solution** for **draining and waterproofing masonry shower trays**. This set includes a stainless-steel gutter and grating, a low-profile siphonic drain, and a WATER-STOP waterproof membrane. The membrane is attached and sealed at the factory to a special adaptor for connection to the drain.

In addition to the wide range of designs and finishes available, the **Evolux Tryphon Kit** is distinguished by the inclusion of our **latest generation Tryphon drain**, which provides the system with a significant advantage in terms of versatility and functionality.

1- Drain of choice. 2- Grate, embellisher, and hair trap EVOLUX (model and size of choice). 3- Grate remover. 4- Mortar level cover. 5- W-S DIN x2 (inside corners). 6- W-S TUB x2 (pass-through pipes). 7- WATER-STOP sheet with thermosealed adapter (2 x 2 m). 8- Evolux Tryphon Kit box.



## COMPLETE SHOWER KIT **EVOLUX TRYPHON KIT**

Evolux Tryphon Kit (with Tryphon Drain)

### Evolux Lisa



FINISHED	PRODUCT							LOGISTIC		
	TRYPHON		TRYPHON REDUCED		MODEL	MEASURE (cm)	W-S MEMBRANE (m)	PCS/ BOX	PCS/ PALLET	
	REF.	FLOW RATE (l/min)	REF.	FLOW RATE (l/min)						
		H.S.*	D.S.*		D.S.*					
●	IT41040	33	47	IT41040R	47	LISA	40	2 x 2 · 4 m <sup>2</sup>	6	40
●	IT41050	33	47	IT41050R	47	LISA	50	2 x 2 · 4 m <sup>2</sup>	6	40
●	IT41000	33	47	IT41000R	47	LISA	60	2 x 2 · 4 m <sup>2</sup>	6	40
●	IT41001	33	47	IT41001R	47	LISA	70	2 x 2 · 4 m <sup>2</sup>	6	40
●	IT41002	33	47	IT41002R	47	LISA	80	2 x 2 · 4 m <sup>2</sup>	6	40
●	IT41003	33	47	IT41003R	47	LISA	90	2 x 2 · 4 m <sup>2</sup>	6	40
●	IT41004	33	47	IT41004R	47	LISA	100	2 x 2 · 4 m <sup>2</sup>	6	40
●	IT41005	33	47	IT41005R	47	LISA	120	2 x 2 · 4 m <sup>2</sup>	3	32
●	IT41150	33	47	IT41150R	47	LISA	150	2 x 2 · 4 m <sup>2</sup>	3	32
●	IT41180	33	47	IT41180R	47	LISA	180	2 x 2 · 4 m <sup>2</sup>	3	32

\* H.S.: Hydraulic Siphon | D.S.: Dry Siphon



## COMPLETE SHOWER KIT **EVOLUX TRYPHON KIT**

Evolux Tryphon Kit (with Tryphon Drain)

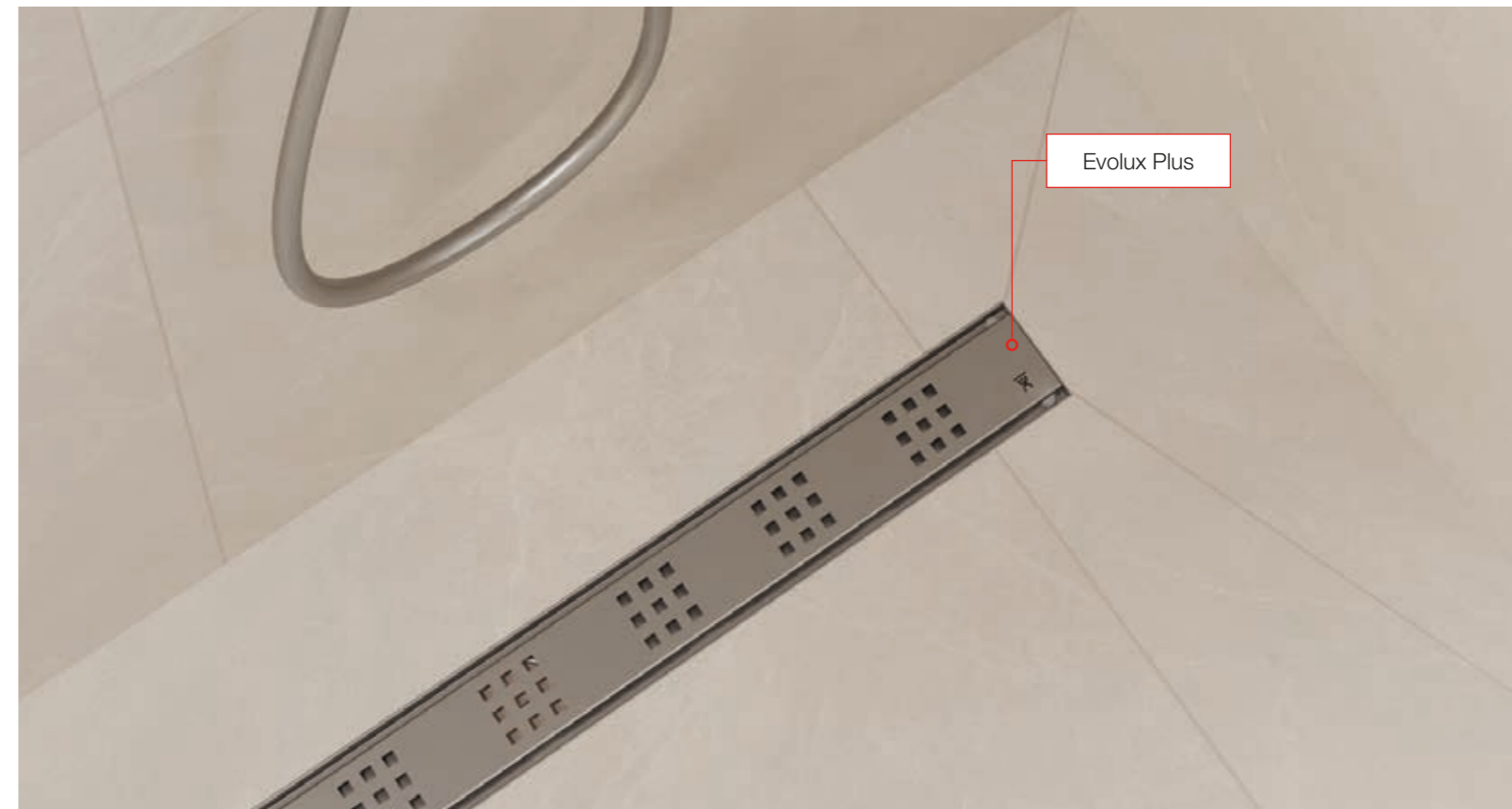

### Evolux Plus



FINISHED	PRODUCT							LOGISTIC		
	TRYPHON		TRYPHON REDUCED		MODEL	MEASURE (cm)	W-S MEMBRANE (m)	PCS/ BOX	PCS/ PALLET	
	REF.	FLOW RATE (l/min)	REF.	FLOW RATE (l/min)						
		H.S.*	D.S.*		D.S.*					
●	IT42000	34	49	IT42000R	49	PLUS	60	2 x 2 · 4 m <sup>2</sup>	6	40
●	IT42001	34	49	IT42001R	49	PLUS	70	2 x 2 · 4 m <sup>2</sup>	6	40
●	IT42002	34	49	IT42002R	49	PLUS	80	2 x 2 · 4 m <sup>2</sup>	6	40
●	IT42003	34	49	IT42003R	49	PLUS	90	2 x 2 · 4 m <sup>2</sup>	6	40
●	IT42004	34	49	IT42004R	49	PLUS	100	2 x 2 · 4 m <sup>2</sup>	6	40
●	IT42005	34	49	IT42005R	49	PLUS	120	2 x 2 · 4 m <sup>2</sup>	3	32
●	IT42150	34	49	IT42150R	49	PLUS	150	2 x 2 · 4 m <sup>2</sup>	3	32
●	IT42180	34	49	IT42180R	49	PLUS	180	2 x 2 · 4 m <sup>2</sup>	3	32

\* H.S.: Hydraulic Siphon | D.S.: Dry Siphon



## COMPLETE SHOWER KIT **EVOLUX TRYPHON KIT**

Evolux Tryphon Kit (with Tryphon Drain)

### Evolux Lisa Gold



FINISHED	PRODUCT								LOGISTIC		
	TRYPHON				TRYPHON REDUCED		MODEL	MEASURE (cm)	W-S MEMBRANE (m)	PCS/ BOX	PCS/ PALLET
	REF.	FLOW RATE (l/min)		REF.	FLOW RATE (l/min)						
	H.S.*	D.S.*		D.S.*							
●	IT61000	33	47	IT61000R	47	LISA GOLD	60	2 x 2 · 4 m <sup>2</sup>	6	40	
●	IT61001	33	47	IT61001R	47	LISA GOLD	70	2 x 2 · 4 m <sup>2</sup>	6	40	
●	IT61002	33	47	IT61002R	47	LISA GOLD	80	2 x 2 · 4 m <sup>2</sup>	6	40	
●	IT61003	33	47	IT61003R	47	LISA GOLD	90	2 x 2 · 4 m <sup>2</sup>	6	40	
●	IT61004	33	47	IT61004R	47	LISA GOLD	100	2 x 2 · 4 m <sup>2</sup>	6	40	
●	IT61005	33	47	IT61005R	47	LISA GOLD	120	2 x 2 · 4 m <sup>2</sup>	3	32	
●	IT61150	33	47	IT61150R	47	LISA GOLD	150	2 x 2 · 4 m <sup>2</sup>	3	32	
●	IT61180	33	47	IT61180R	47	LISA GOLD	180	2 x 2 · 4 m <sup>2</sup>	3	32	

\* H.S.: Hydraulic Siphon | D.S.: Dry Siphon



## COMPLETE SHOWER KIT **EVOLUX TRYPHON KIT**

Evolux Tryphon Kit (with Tryphon Drain)

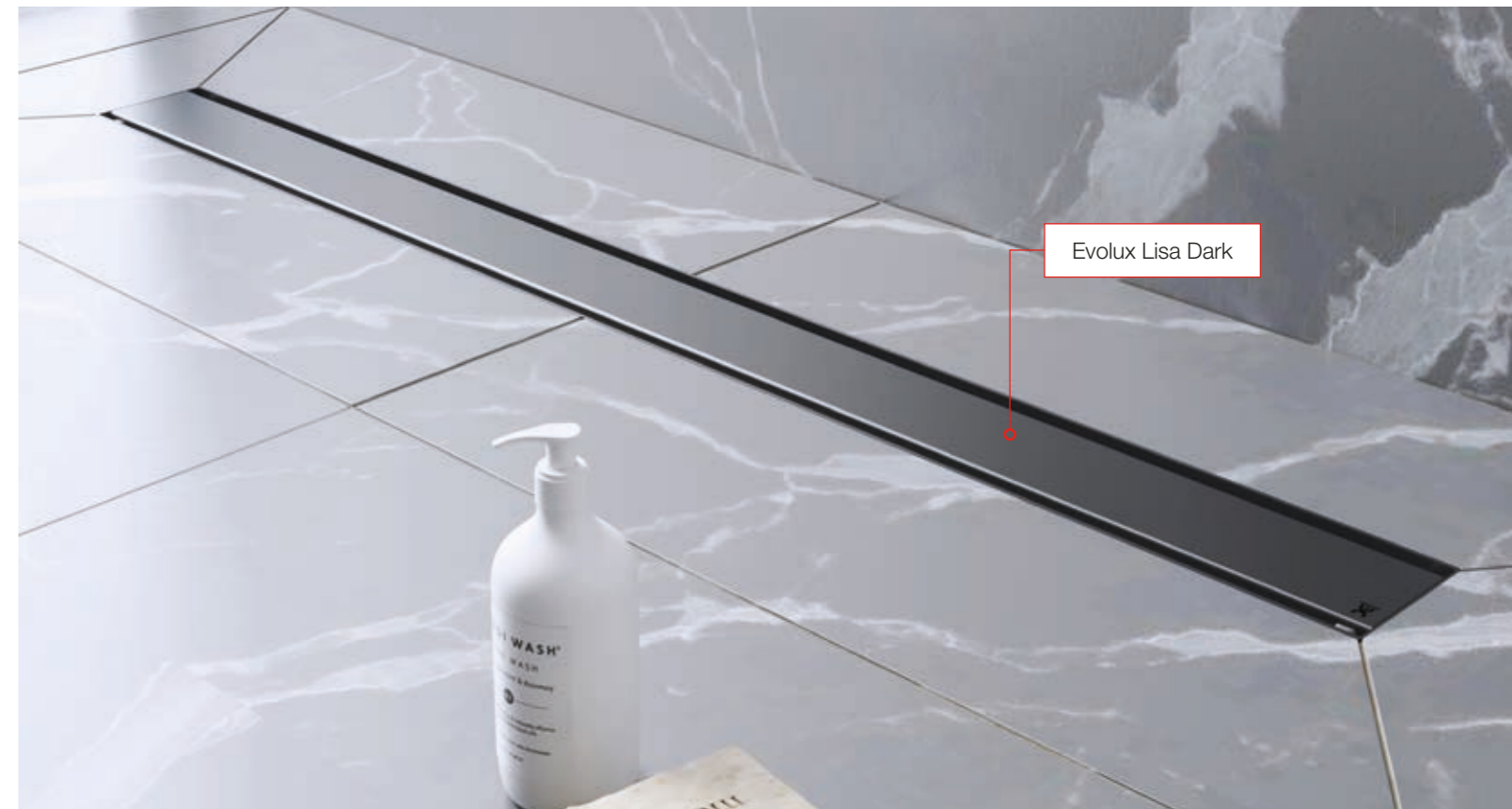

### Evolux Lisa Dark



FINISHED	PRODUCT								LOGISTIC		
	TRYPHON				TRYPHON REDUCED		MODEL	MEASURE (cm)	W-S MEMBRANE (m)	PCS/ BOX	PCS/ PALLET
	REF.	FLOW RATE (l/min)		REF.	FLOW RATE (l/min)						
	H.S.*	D.S.*		D.S.*							
●	IT51000	33	47	IT51000R	47	LISA DARK	60	2 x 2 · 4 m <sup>2</sup>	6	40	
●	IT51001	33	47	IT51001R	47	LISA DARK	70	2 x 2 · 4 m <sup>2</sup>	6	40	
●	IT51002	33	47	IT51002R	47	LISA DARK	80	2 x 2 · 4 m <sup>2</sup>	6	40	
●	IT51003	33	47	IT51003R	47	LISA DARK	90	2 x 2 · 4 m <sup>2</sup>	6	40	
●	IT51004	33	47	IT51004R	47	LISA DARK	100	2 x 2 · 4 m <sup>2</sup>	6	40	
●	IT51005	33	47	IT51005R	47	LISA DARK	120	2 x 2 · 4 m <sup>2</sup>	3	32	
●	IT51150	33	47	IT51150R	47	LISA DARK	150	2 x 2 · 4 m <sup>2</sup>	3	32	
●	IT51180	33	47	IT51180R	47	LISA DARK	180	2 x 2 · 4 m <sup>2</sup>	3	32	

\* H.S.: Hydraulic Siphon | D.S.: Dry Siphon



## COMPLETE SHOWER KIT **EVOLUX TRYPHON KIT**

Evolux Tryphon Kit (with Tryphon Drain)

### Evolux Microcement

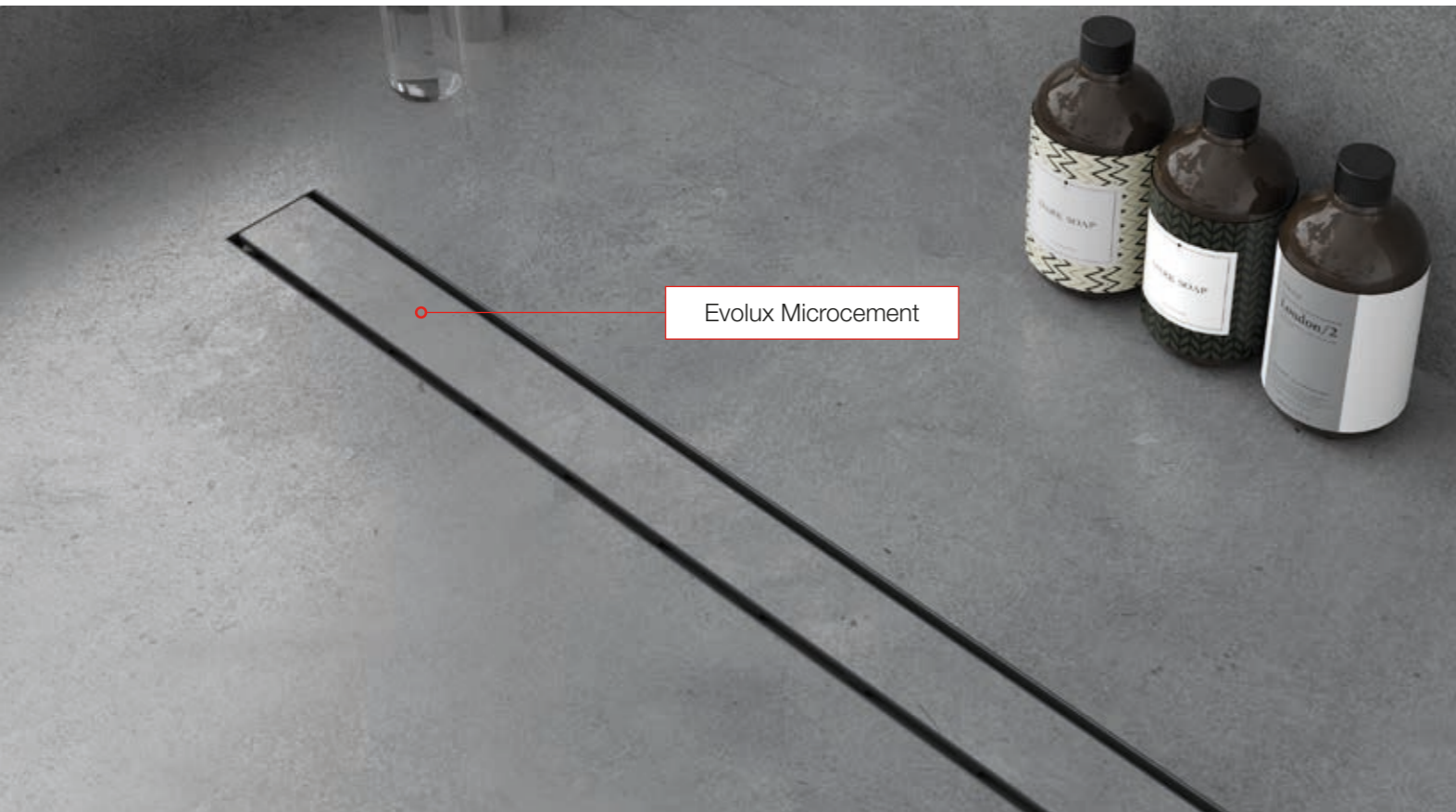

Evolux Microcement



FINISHED	PRODUCT								LOGISTIC	
	TRYPHON			TRYPHON REDUCED		MODEL	MEASURE (cm)	W-S MEMBRANE (m)	PCS/ BOX	PCS/ PALLET
	REF.	FLOW RATE (l/min)		REF.	FLOW RATE (l/min)					
	H.S.*	D.S.*		D.S.*						
●	IT47000	30	46	IT47000R	46	MICROCEMENT	60	2 x 2 · 4 m <sup>2</sup>	6	40
●	IT47001	30	46	IT47001R	46	MICROCEMENT	70	2 x 2 · 4 m <sup>2</sup>	6	40
●	IT47002	30	46	IT47002R	46	MICROCEMENT	80	2 x 2 · 4 m <sup>2</sup>	6	40
●	IT47003	30	46	IT47003R	46	MICROCEMENT	90	2 x 2 · 4 m <sup>2</sup>	6	40
●	IT47004	30	46	IT47004R	46	MICROCEMENT	100	2 x 2 · 4 m <sup>2</sup>	6	40
●	IT47005	30	46	IT47005R	46	MICROCEMENT	120	2 x 2 · 4 m <sup>2</sup>	3	32

\* H.S.: Hydraulic Siphon | D.S.: Dry Siphon



COMPLETE SHOWER KIT **EVOLUX TRYPHON KIT INTEGRA**



Scan the QR code and discover more



Pavementable design, now more reinforced.

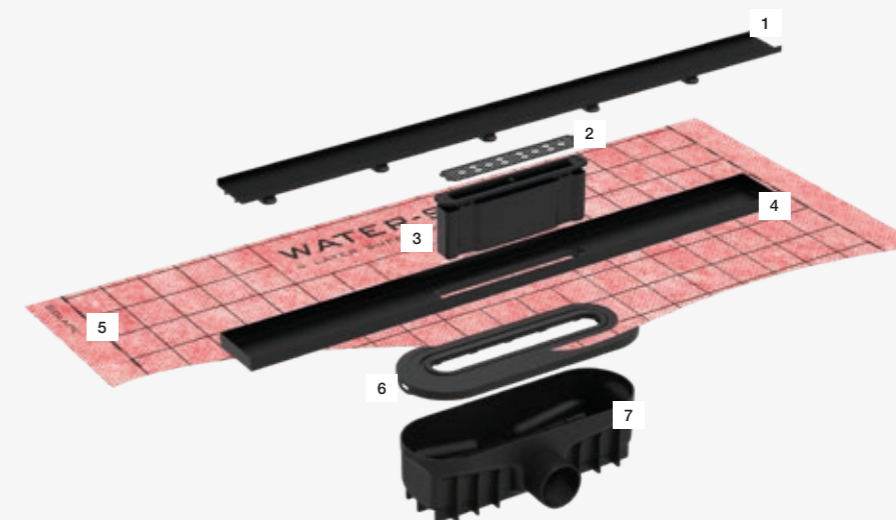

- 1. Evolux Integra grille
- 2. Hair collector
- 3. Siphon
- 4. Evolux Integra gutter
- 5. Water-Stop membrane
- 6. Adapter
- 7. Siphon Trap

**Features**

- » Reinforced structure
- » Maximum strength with minimal weight
- » Included waterproofing
- » High drainage capacity
- » Easy installation
- » Effective cleaning
- » 10-year warranty

**Specifications**

- » Stainless steel AISI 304 channel with textured paint
- » Aluminum grate with textured paint
- » Slots with dovetail to maximize adhesive grip
- » Installation height:
  - » Self-centering grate using centering feet

TRYPHON	TRYPHON REDUCED	TRYPHON VERTICAL
93 mm + PAVEMENT	74 mm + PAVEMENT	88 mm + PAVEMENT

**The system includes**

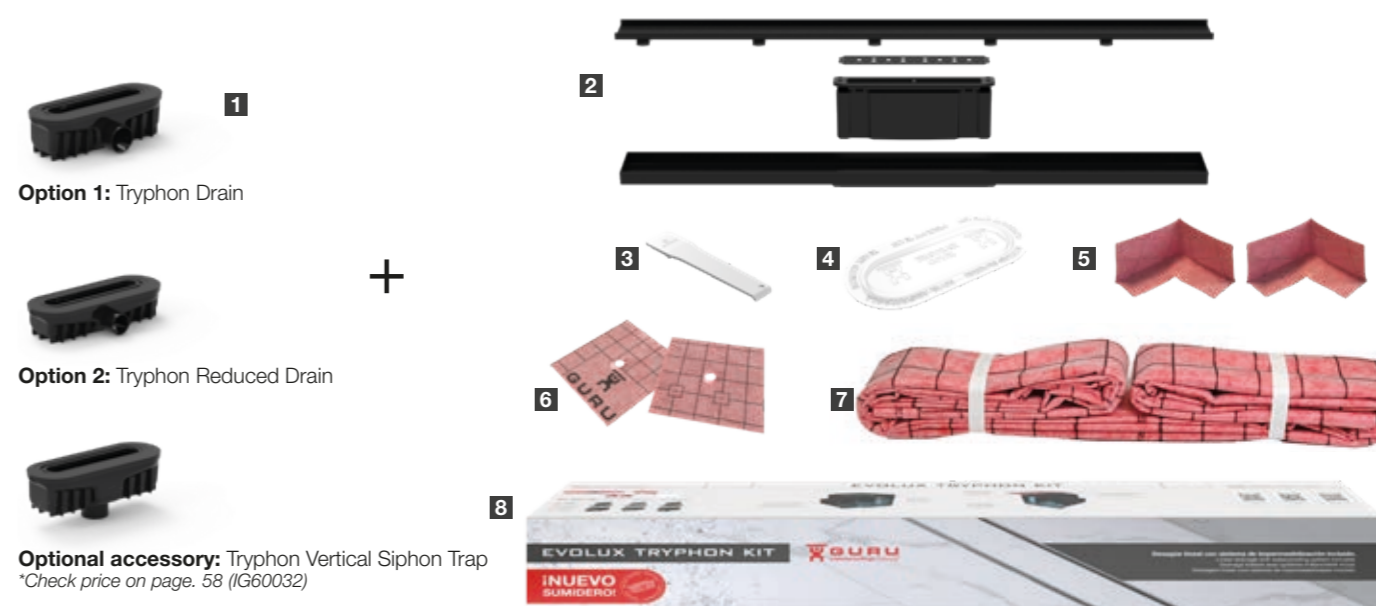

**Option 1:** Tryphon Drain

**Option 2:** Tryphon Reduced Drain

**Optional accessory:** Tryphon Vertical Siphon Trap  
\*Check price on page. 58 (IG60032)

The new **reinforced model of INTEGRA** represents an enhanced version of its predecessor, the integrated drain. This innovative piece has been meticulously designed to deliver exceptional performance in large ceramic applications, ensuring increased durability and stability during installation.

A distinctive feature is its **dovetail system**, ensuring optimal grip on ceramic pieces, facilitating their precise and secure placement. Additionally, it features an **invisible edge** that provides an aesthetic and elegant finish to the installation, keeping the focus on the design and beauty of the ceramics.

Manufactured in **6016-T6 aluminum**, it combines **strength** and **lightness**, making it the ideal choice for projects that demand high performance and quality. INTEGRA FORCE is the perfect solution for those seeking a combination of functionality and aesthetics in their ceramic projects.

- 1- Drain of choice. 2- Evolux Integra Tryphon channel and grate with siphon and embellisher (model and size of choice). 3- Grate remover. 4- Mortar level cover.
- 5- W-S DIN x2 (inside corners). 6- W-S TUB x2 (pass-through pipes). 7- WATER-STOP sheet with thermosealed adapter (2 x 2 m). 8- Evolux Tryphon Kit box.



**COMPLETE SHOWER KIT EVOLUX TRYPHON KIT INTEGRA**

Evolux Tryphon Kit (with Tryphon Drain)

FINISHED	PRODUCT								LOGISTIC		
	TRYPHON				TRYPHON REDUCED		MODEL	MEASURE (cm)	W-S MEMBRANE (m)	PCS/ BOX	PCS/ PALLET
	REF.	FLOW RATE (l/min)		REF.	FLOW RATE (l/min)						
	H.S.*	D.S.*		D.S.*							
-	IT45040	32	47	IT45040R	47	INTEGRA	40	2 x 2 · 4 m <sup>2</sup>	6	40	
-	IT45050	32	47	IT45050R	47	INTEGRA	50	2 x 2 · 4 m <sup>2</sup>	6	40	
-	IT45000	32	47	IT45000R	47	INTEGRA	60	2 x 2 · 4 m <sup>2</sup>	6	40	
-	IT45001	32	47	IT45001R	47	INTEGRA	70	2 x 2 · 4 m <sup>2</sup>	6	40	
-	IT45002	32	47	IT45002R	47	INTEGRA	80	2 x 2 · 4 m <sup>2</sup>	6	40	
-	IT45003	32	47	IT45003R	47	INTEGRA	90	2 x 2 · 4 m <sup>2</sup>	6	40	
-	IT45004	32	47	IT45004R	47	INTEGRA	100	2 x 2 · 4 m <sup>2</sup>	6	40	
-	IT45005	32	47	IT45005R	47	INTEGRA	120	2 x 2 · 4 m <sup>2</sup>	3	32	
-	IT45150	32	47	IT45150R	47	INTEGRA	150	2 x 2 · 4 m <sup>2</sup>	3	32	
-	IT45180	32	47	IT45180R	47	INTEGRA	180	2 x 2 · 4 m <sup>2</sup>	3	32	

\* H.S.: Hydraulic Siphon | D.S.: Dry Siphon

Evolux Integra - Paved





**DRAIN RUBER**

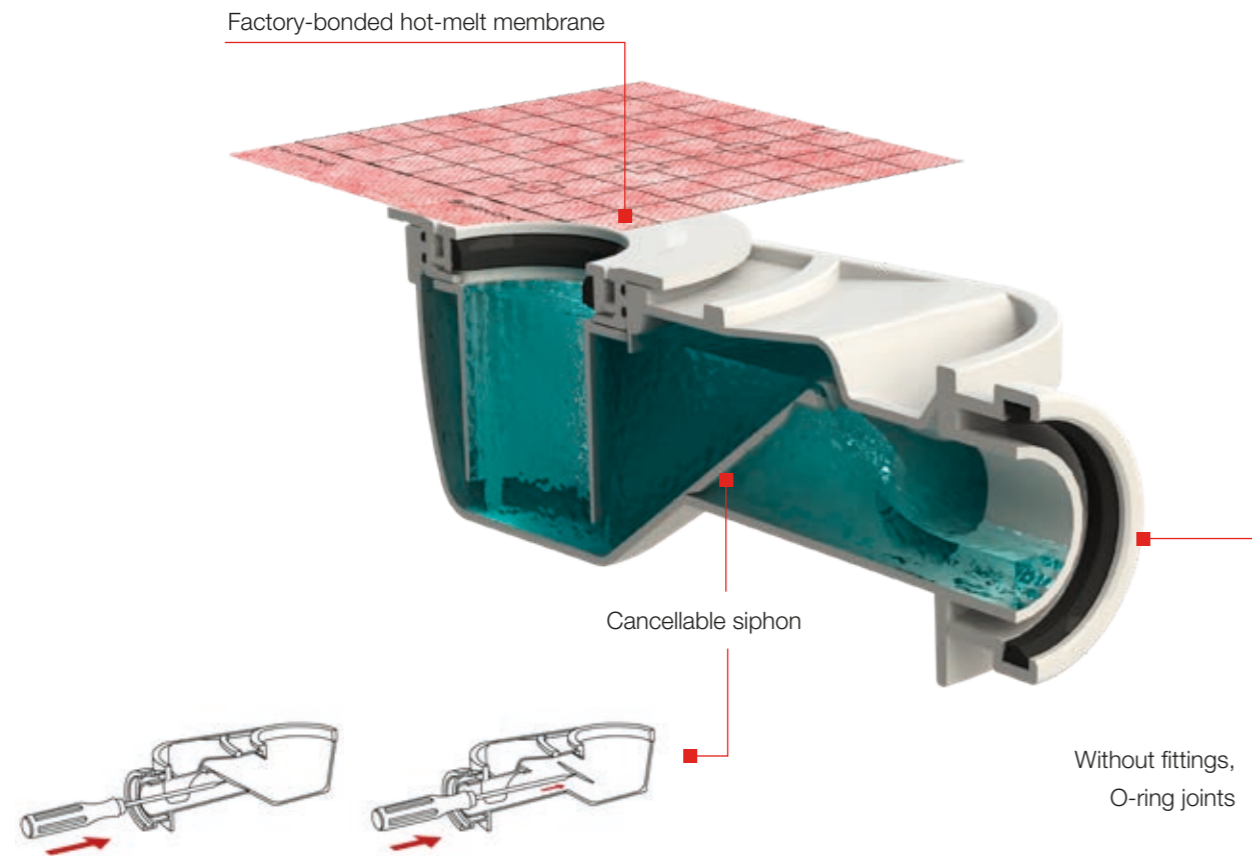
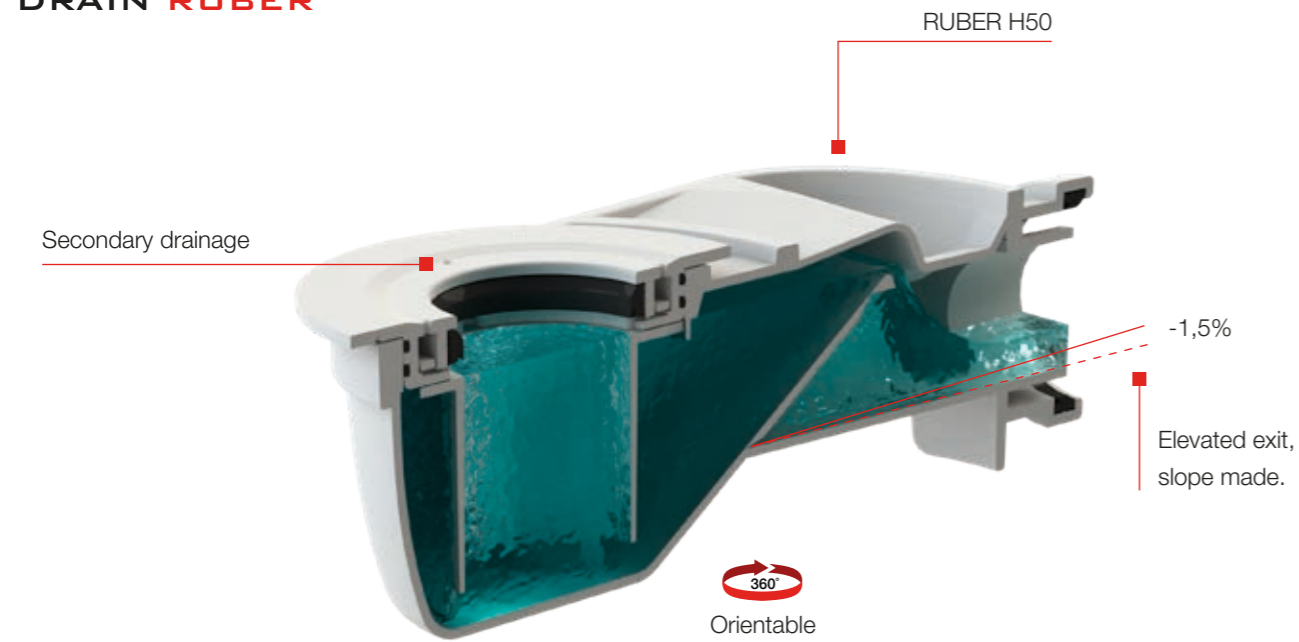

**OPTIONAL RUBER ACCESSORY:**

PRODUCT			
REF.	DESCRIPTION	SIPHON	FLOW RATE (l/min)
IG60030	RUBER H28 DRAIN	HEIGHT 28 mm	36

**RUBER H50**



**RUBER H28**



**Two height options:**

**RUBER H50** Drain with siphon of 50 mm height, total installation height 90 mm.

- Ø 50 mm outlet
- Connection with pressure seal

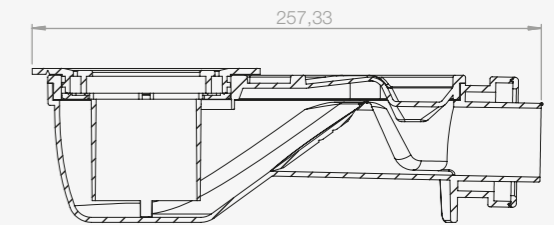
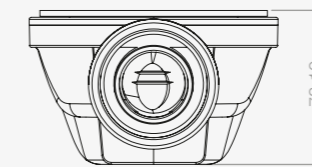
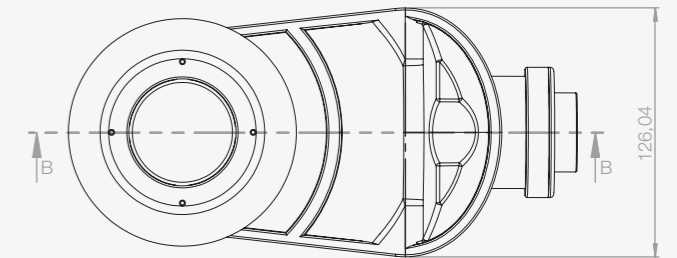

SECCIÓN B-B

**RUBER H28** Drain with siphon of 28 mm height, total installation height 70 mm.

- Ø 40 mm outlet
- Connection via gluing

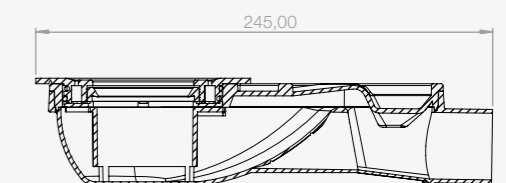
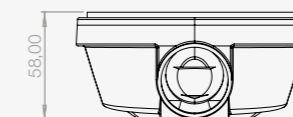
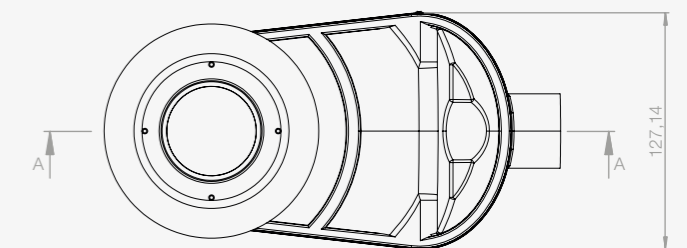

SECCIÓN A-A



COMPLETE SHOWER KIT **EVO SYSTEM**



Scan the QR code and discover more

Efficiency at the best price



The EVO System is a **shower system** that includes **waterproofing around the drain** to provide protection against water damage in areas with floor drainage.

The product comprises a trap drain with a low profile, a WATER-STOP waterproof sheet that is pre-attached and sealed to a special adapter for connecting to the drain, and a stainless-steel grille with an ABS bowl.

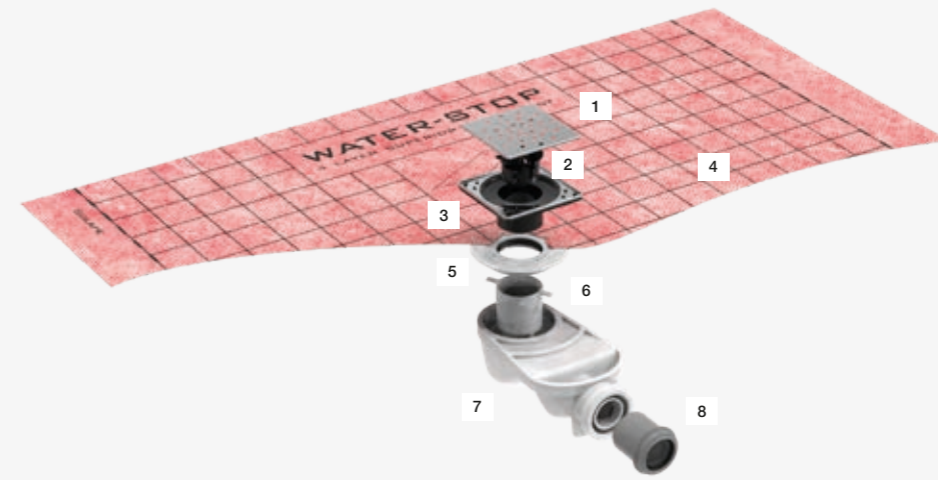

1. Evo grille
2. Hair collector
3. EVO Shower drain
4. Water-Stop membrane
5. Adapter
6. Ruber shower head
7. Ruber siphonic body
8. Reducer Ø 50/40 mm

**Features**

- » Waterproofing included
- » Drainage position: 60 cm from the edge
- » High drainage capacity
- » Easy installation
- » Effective cleaning
- » 10-year warranty

**Specifications**

- » Elastic joints
- » Secondary drainage
- » 360° adjustable
- » Minimum installation height: 90 mm (Ruber H50 drain)
- » Minimum installation height: 70 mm (Ruber H28 drain)

**The system includes**

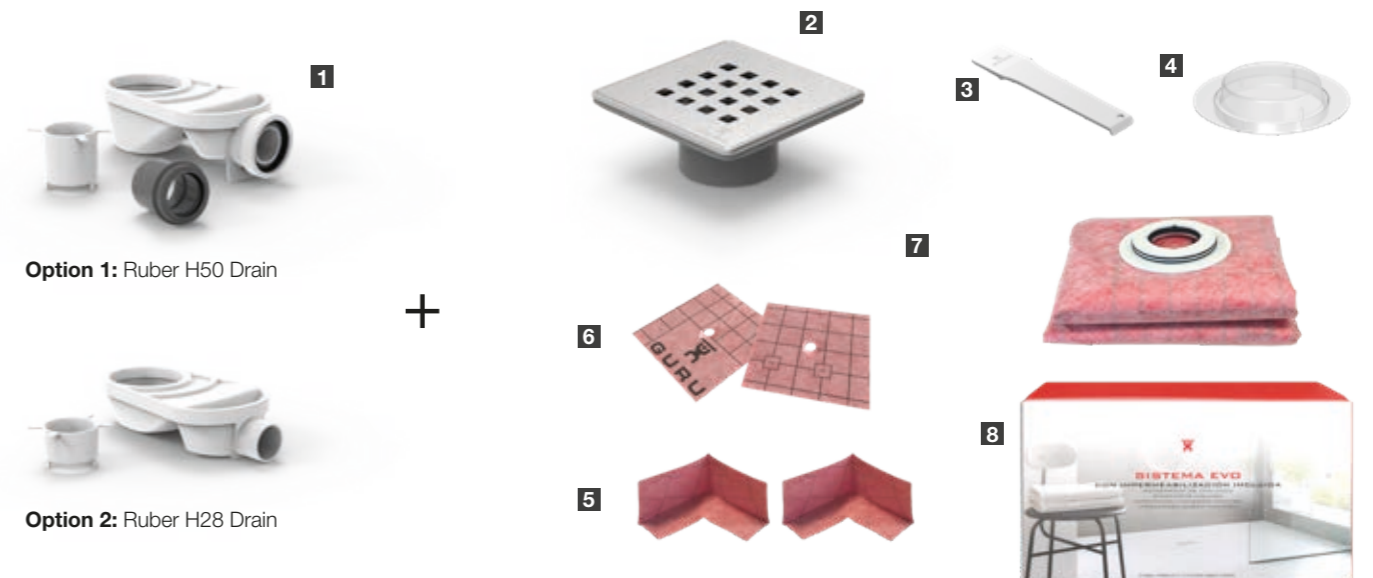

1- Drain of choice. 2- ABS cup and stainless steel grate (model of choice). 3- Grate remover. 4- Mortar level cover. 5- W-S DIN x2 (inside corners). 6- W-S TUB x2 (pass-through pipes). 7- WATER-STOP membrane with thermosealed adapter (1.5 x 2 m). 8- Evo box.



## COMPLETE SHOWER KIT EVO SYSTEM

Evo System (with Ruber Drain)

FINISHED	PRODUCT					LOGISTICS	
	REF. RUBER H50	REF. RUBER H28	FLOW RATE (l/min)	DESCRIPTION	W-S MEBRANE	PCS/BOX	PCS/PALLET
●	IB20015	IB20015R	24	EVO	1,5 x 2 · 3 m <sup>2</sup>	6	84
●	IB20016	IB20016R	26	PLUS EVO	1,5 x 2 · 3 m <sup>2</sup>	6	84
●	IB20017	IB20017R	26	ONDE EVO	1,5 x 2 · 3 m <sup>2</sup>	6	84
●	IB20007	IB20007R	26	ANTIVANDAL	1,5 x 2 · 3 m <sup>2</sup>	6	84

Evo Colors System (with Ruber Drain)

FINISHED	PRODUCT					LOGISTICS	
	REF. RUBER H50	REF. RUBER H28	FLOW RATE (l/min)	DESCRIPTION	W-S MEBRANE	PCS/BOX	PCS/PALLET
●	IB20018	IB20018R	26	EVO POLISHED	1,5 x 2 · 3 m <sup>2</sup>	6	84
●	IB20019	IB20019R	26	EVO BLACK	1,5 x 2 · 3 m <sup>2</sup>	6	84
●	IB20020	IB20020R	26	EVO BRONZE	1,5 x 2 · 3 m <sup>2</sup>	6	84
●	IB20021	IB20021R	26	EVO GOLD	1,5 x 2 · 3 m <sup>2</sup>	6	84
●	IB20023	IB20023R	26	EVO MINT	1,5 x 2 · 3 m <sup>2</sup>	6	84
●	IB20024	IB20024R	26	EVO ROSE	1,5 x 2 · 3 m <sup>2</sup>	6	84
●	IB20025	IB20025R	26	EVO SAPPHIRE	1,5 x 2 · 3 m <sup>2</sup>	6	84
○	IB20026	IB20026R	26	EVO SNOWY	1,5 x 2 · 3 m <sup>2</sup>	6	84

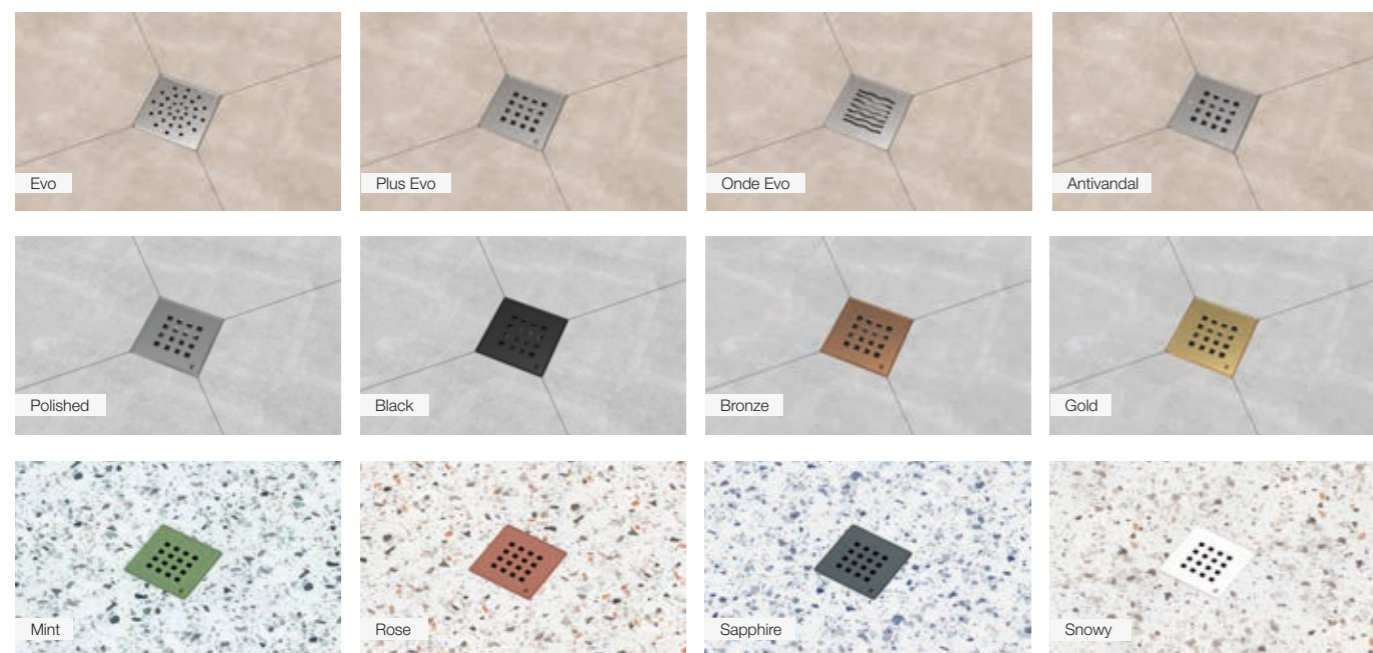



COMPLETE SHOWER KIT **EVOLUX RUBER KIT**



Scan the QR code and discover more

Evolux, equal parts effectiveness and efficiency.

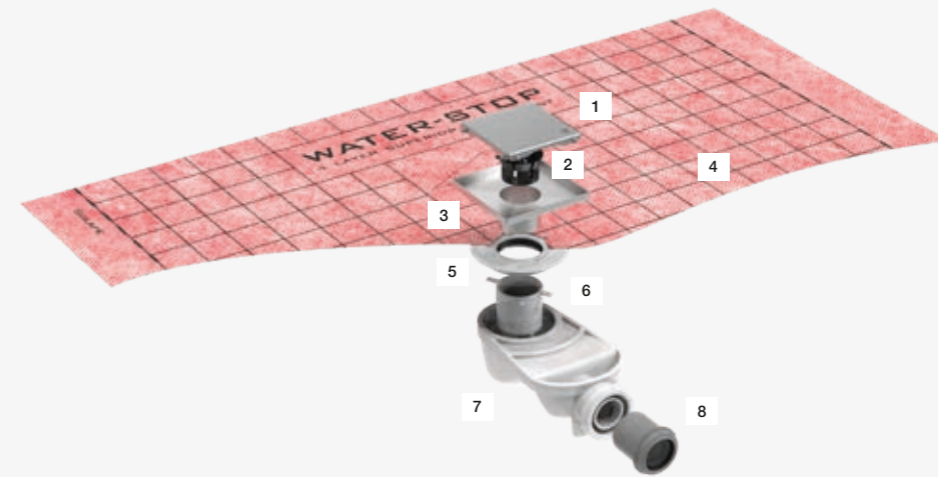

1. Evolux Square Grid
2. Hair collector
3. Evolux shower drain
4. Water-Stop membrane
5. Adapter
6. Ruber shower head
7. Ruber siphonic body
8. Reducer Ø 50/40 mm

**Features**

- » Stainless steel structure
- » Resistance to high loads
- » Waterproofing included
- » High drainage capacity
- » Easy installation
- » Effective cleaning
- » 10-year warranty

**Specifications**

- » Elastic joints
- » Secondary drainage
- » 360° adjustable
- » Minimum installation height: 90 mm (Ruber H50 drain)
- » Minimum installation height: 70 mm (Ruber H28 drain)

**The system includes**

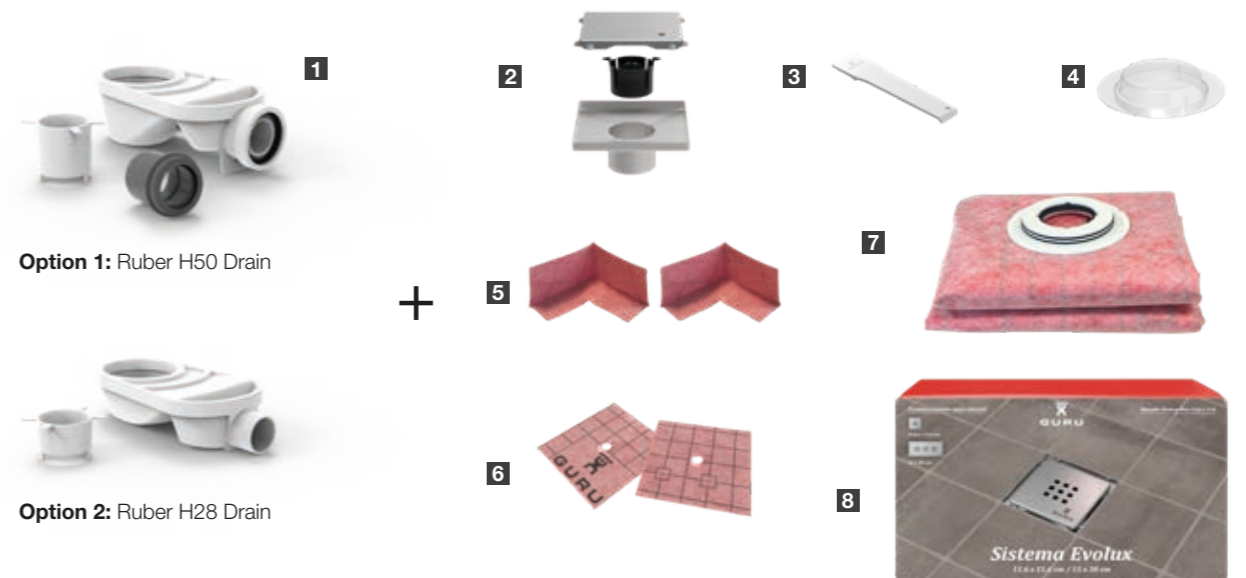

Option 1: Ruber H50 Drain

Option 2: Ruber H28 Drain

Evolux shower system offers a **complete solution** for the **drainage and waterproofing of masonry shower trays**. This set includes a stainless-steel gutter and grating, a low-profile siphonic drain, and a WATER-STOP waterproof membrane. The membrane is attached and sealed at the factory to a special adaptor for connection to the drain.

Furthermore, a diverse selection of designs and finishes is available for you to choose from: **paveable grating, microcement, stainless steel, gold, black...**

1- Drain of choice. 2- Evolux channel and grate (model, size, and finish of choice). 3- Grate remover. 4- Mortar level cover. 5- W-S DIN x2 (inside corners). 6- W-S TUB x2 (pass-through pipes). 7- WATER-STOP sheet with thermosealed adapter (1.5 x 2 m/ 2 x 2 m). 8- Evolux Ruber Kit box.



### COMPLETE SHOWER KIT EVOLUX SQUARE RUBER KIT

Evolux Square Ruber Kit (with Ruber Drain)

FINISHED	PRODUCT						LOGISTICS	
	REF. RUBER H50	REF. RUBER H28	FLOW RATE (l/m)	MODEL	MEASURE (cm)	W-S MEBRANE (m)	PCS/ BOX	PCS/ PALLET
●	IE41008	IE41008R	26	LISA	11,6 x 11,6	1,5 x 2 · 3 m <sup>2</sup>	3	50
●	IE42708	IE42708R	26	PLUS ANTIVANDAL	11,6 x 11,6	1,5 x 2 · 3 m <sup>2</sup>	3	50
●	IE41009	IE41009R	27	LISA	15 x 30	1,5 x 2 · 3 m <sup>2</sup>	3	50
●	IE42008	IE42008R	28	PLUS	11,6 x 11,6	1,5 x 2 · 3 m <sup>2</sup>	3	50
●	IE42009	IE42009R	29	PLUS	15 x 30	1,5 x 2 · 3 m <sup>2</sup>	3	50
●	IE51008	IE51008R	26	LISA DARK	11,6 x 11,6	1,5 x 2 · 3 m <sup>2</sup>	3	50
●	IE51009	IE51009R	27	LISA DARK	15 x 30	1,5 x 2 · 3 m <sup>2</sup>	3	50
●	IE60008	IE60008R	28	BEAT DARK	11,6 x 11,6	1,5 x 2 · 3 m <sup>2</sup>	3	50
○	IE61108	IE61108R	26	LISA LIGHT	11,6 x 11,6	1,5 x 2 · 3 m <sup>2</sup>	3	50
○	IE62108	IE62108R	28	PLUS LIGHT	11,6 x 11,6	1,5 x 2 · 3 m <sup>2</sup>	3	50
○	IE61708	IE61708R	28	BLUES LIGHT	11,6 x 11,6	1,5 x 2 · 3 m <sup>2</sup>	3	50
●	IE47008	IE47008R	25	MICROCEMENT	11,6 x 11,6	1,5 x 2 · 3 m <sup>2</sup>	3	50
●	IE47009	IE47009R	26	MICROCEMENT	15 x 30	1,5 x 2 · 3 m <sup>2</sup>	3	50
●	IE67008	IE67008R	25	MICRO GOLD	11,6 x 11,6	1,5 x 2 · 3 m <sup>2</sup>	3	50
●	IE67009	IE67009R	26	MICRO GOLD	15 x 30	1,5 x 2 · 3 m <sup>2</sup>	3	50
●	IE57008	IE57008R	25	MICRO DARK	11,6 x 11,6	1,5 x 2 · 3 m <sup>2</sup>	3	50
●	IE57009	IE57009R	26	MICRO DARK	15 x 30	1,5 x 2 · 3 m <sup>2</sup>	3	50
○	IE49009	IE49009R	27	CRISTAL	15 x 30	1,5 x 2 · 3 m <sup>2</sup>	3	50
-	IE45008	IE45008R	26	INTEGRA	11,6 x 11,6	1,5 x 2 · 3 m <sup>2</sup>	3	50
-	IE45009	IE45009R	25	INTEGRA	15 x 30	1,5 x 2 · 3 m <sup>2</sup>	3	50

### COMPLETE SHOWER KIT EVOLUX LINEAL RUBER KIT

Evolux Lineal Ruber Kit (with Ruber Drain)

FINISHED	PRODUCT						LOGISTICS	
	REF. RUBER H50	REF. RUBER H28	FLOW RATE (l/m)	MODEL	MEASURE (cm)	W-S MEBRANE (m)	PCS/ BOX	PCS/ PALLET
●	IE41040	IE41040R	27	LISA	40	2 x 2 · 4 m <sup>2</sup>	6	40
●	IE41050	IE41050R	27	LISA	50	2 x 2 · 4 m <sup>2</sup>	6	40
●	IE41000	IE41000R	27	LISA	60	2 x 2 · 4 m <sup>2</sup>	6	40
●	IE41001	IE41001R	27	LISA	70	2 x 2 · 4 m <sup>2</sup>	6	40

●	IE41002	IE41002R	27	LISA	80	2 x 2 · 4 m <sup>2</sup>	6	40
●	IE41003	IE41003R	27	LISA	90	2 x 2 · 4 m <sup>2</sup>	6	40
●	IE41004	IE41004R	27	LISA	100	2 x 2 · 4 m <sup>2</sup>	6	40
●	IE41005	IE41005R	27	LISA	120	2 x 2 · 4 m <sup>2</sup>	3	32
●	IE41150	IE41150R	27	LISA	150	2 x 2 · 4 m <sup>2</sup>	3	32
●	IE41180	IE41180R	27	LISA	180	2 x 2 · 4 m <sup>2</sup>	3	32
●	IE42000	IE42000R	28	PLUS	60	2 x 2 · 4 m <sup>2</sup>	6	40
●	IE42001	IE42001R	28	PLUS	70	2 x 2 · 4 m <sup>2</sup>	6	40
●	IE42002	IE42002R	28	PLUS	80	2 x 2 · 4 m <sup>2</sup>	6	40
●	IE42003	IE42003R	28	PLUS	90	2 x 2 · 4 m <sup>2</sup>	6	40
●	IE42004	IE42004R	28	PLUS	100	2 x 2 · 4 m <sup>2</sup>	6	40
●	IE42005	IE42005R	28	PLUS	120	2 x 2 · 4 m <sup>2</sup>	3	32
●	IE42150	IE42150R	28	PLUS	150	2 x 2 · 4 m <sup>2</sup>	3	32
●	IE42180	IE42180R	28	PLUS	180	2 x 2 · 4 m <sup>2</sup>	3	32
●	IE61000	IE61000R	27	LISA GOLD	60	2 x 2 · 4 m <sup>2</sup>	6	40
●	IE61001	IE61001R	27	LISA GOLD	70	2 x 2 · 4 m <sup>2</sup>	6	40
●	IE61002	IE61002R	27	LISA GOLD	80	2 x 2 · 4 m <sup>2</sup>	6	40
●	IE61003	IE61003R	27	LISA GOLD	90	2 x 2 · 4 m <sup>2</sup>	6	40
●	IE51000	IE51000R	27	LISA DARK	60	2 x 2 · 4 m <sup>2</sup>	6	40
●	IE51001	IE51001R	27	LISA DARK	70	2 x 2 · 4 m <sup>2</sup>	6	40
●	IE51002	IE51002R	27	LISA DARK	80	2 x 2 · 4 m <sup>2</sup>	6	40
●	IE51003	IE51003R	27	LISA DARK	90	2 x 2 · 4 m <sup>2</sup>	6	40
●	IE51004	IE51004R	27	LISA DARK	100	2 x 2 · 4 m <sup>2</sup>	6	40
●	IE51005	IE51005R	27	LISA DARK	120	2 x 2 · 4 m <sup>2</sup>	3	32
●	IE51150	IE51150R	27	LISA DARK	150	2 x 2 · 4 m <sup>2</sup>	3	32
●	IE51180	IE51180R	27	LISA DARK	180	2 x 2 · 4 m <sup>2</sup>	3	32
○	IE68000	IE68000R	27	LISA LIGHT	60	2 x 2 · 4 m <sup>2</sup>	6	40
○	IE68001	IE68001R	27	LISA LIGHT	70	2 x 2 · 4 m <sup>2</sup>	6	40
○	IE68002	IE68002R	27	LISA LIGHT	80	2 x 2 · 4 m <sup>2</sup>	6	40
○	IE68003	IE68003R	27	LISA LIGHT	90	2 x 2 · 4 m <sup>2</sup>	6	40
○	IE68004	IE68004R	27	LISA LIGHT	100	2 x 2 · 4 m <sup>2</sup>	6	40
○	IE68005	IE68005R	27	LISA LIGHT	120	2 x 2 · 4 m <sup>2</sup>	3	32
○	IE68150	IE68150R	27	LISA LIGHT	150	2 x 2 · 4 m <sup>2</sup>	3	32
○	IE68180	IE68180R	27	LISA LIGHT	180	2 x 2 · 4 m <sup>2</sup>	3	32



### COMPLETE SHOWER KIT EVOLUX LINEAL RUBER KIT

Evolux Lineal Ruber Kit (with Ruber Drain)

FINISHED	PRODUCT						LOGISTICS	
	REF. RUBER H50	REF. RUBER H28	FLOW RATE (l/m)	MODEL	MEASURE (cm)	W-S MEBRANE (m)	PCS/BOX	PCS/PALLET
●	IE61300	IE61300R	27	LISA STONE	60	2 x 2 · 4 m <sup>2</sup>	6	40
●	IE61301	IE61301R	27	LISA STONE	70	2 x 2 · 4 m <sup>2</sup>	6	40
●	IE61302	IE61302R	27	LISA STONE	80	2 x 2 · 4 m <sup>2</sup>	6	40
●	IE61303	IE61303R	27	LISA STONE	90	2 x 2 · 4 m <sup>2</sup>	6	40
●	IE61304	IE61304R	27	LISA STONE	100	2 x 2 · 4 m <sup>2</sup>	6	40
●	IE61305	IE61305R	27	LISA STONE	120	2 x 2 · 4 m <sup>2</sup>	3	32
●	IE61400	IE61400R	27	LISA CHOCOLATE	60	2 x 2 · 4 m <sup>2</sup>	6	40
●	IE61401	IE61401R	27	LISA CHOCOLATE	70	2 x 2 · 4 m <sup>2</sup>	6	40
●	IE61402	IE61402R	27	LISA CHOCOLATE	80	2 x 2 · 4 m <sup>2</sup>	6	40
●	IE61403	IE61403R	27	LISA CHOCOLATE	90	2 x 2 · 4 m <sup>2</sup>	6	40
●	IE61404	IE61404R	27	LISA CHOCOLATE	100	2 x 2 · 4 m <sup>2</sup>	6	40
●	IE61405	IE61405R	27	LISA CHOCOLATE	120	2 x 2 · 4 m <sup>2</sup>	3	32
●	IE61500	IE61500R	27	LISA GREY	60	2 x 2 · 4 m <sup>2</sup>	6	40
●	IE61501	IE61501R	27	LISA GREY	70	2 x 2 · 4 m <sup>2</sup>	6	40
●	IE61502	IE61502R	27	LISA GREY	80	2 x 2 · 4 m <sup>2</sup>	6	40
●	IE61503	IE61503R	27	LISA GREY	90	2 x 2 · 4 m <sup>2</sup>	6	40
●	IE61504	IE61504R	27	LISA GREY	100	2 x 2 · 4 m <sup>2</sup>	6	40
●	IE61505	IE61505R	27	LISA GREY	120	2 x 2 · 4 m <sup>2</sup>	6	40
●	IE61600	IE61600R	27	LISA CREAM	60	2 x 2 · 4 m <sup>2</sup>	6	40
●	IE61601	IE61601R	27	LISA CREAM	70	2 x 2 · 4 m <sup>2</sup>	6	40
●	IE61602	IE61602R	27	LISA CREAM	80	2 x 2 · 4 m <sup>2</sup>	6	40
●	IE61603	IE61603R	27	LISA CREAM	90	2 x 2 · 4 m <sup>2</sup>	6	40
●	IE61604	IE61604R	27	LISA CREAM	100	2 x 2 · 4 m <sup>2</sup>	6	40
●	IE61605	IE61605R	27	LISA CREAM	120	2 x 2 · 4 m <sup>2</sup>	3	32
○	IE49001	IE49001R	27	CRISTAL	70	2 x 2 · 4 m <sup>2</sup>	6	40
○	IE49002	IE49002R	27	CRISTAL	80	2 x 2 · 4 m <sup>2</sup>	6	40
○	IE49003	IE49003R	27	CRISTAL	90	2 x 2 · 4 m <sup>2</sup>	6	40

### COMPLETE SHOWER KIT EVOLUX LINEAL RUBER KIT

Evolux Lineal Ruber Kit (with Ruber Drain)

FINISHED	PRODUCT						LOGISTICS	
	REF. RUBER H50	REF. RUBER H28	FLOW RATE (l/m)	MODEL	MEASURE (cm)	W-S MEBRANE (m)	PCS/BOX	PCS/PALLET
●	IE47000	IE47000R	24	MICROCEMENT	60	2 x 2 · 4 m <sup>2</sup>	6	40
●	IE47001	IE47001R	24	MICROCEMENT	70	2 x 2 · 4 m <sup>2</sup>	6	40
●	IE47002	IE47002R	24	MICROCEMENT	80	2 x 2 · 4 m <sup>2</sup>	6	40
●	IE47003	IE47003R	24	MICROCEMENT	90	2 x 2 · 4 m <sup>2</sup>	6	40
●	IE47004	IE47004R	24	MICROCEMENT	100	2 x 2 · 4 m <sup>2</sup>	6	40
●	IE47005	IE47005R	24	MICROCEMENT	120	2 x 2 · 4 m <sup>2</sup>	3	32
●	IE67000	IE67000R	24	MICRO GOLD	60	2 x 2 · 4 m <sup>2</sup>	6	40
●	IE67001	IE67001R	24	MICRO GOLD	70	2 x 2 · 4 m <sup>2</sup>	6	40
●	IE67002	IE67002R	24	MICRO GOLD	80	2 x 2 · 4 m <sup>2</sup>	6	40
●	IE67003	IE67003R	24	MICRO GOLD	90	2 x 2 · 4 m <sup>2</sup>	6	40
●	IE57000	IE57000R	24	MICRO DARK	60	2 x 2 · 4 m <sup>2</sup>	6	40
●	IE57001	IE57001R	24	MICRO DARK	70	2 x 2 · 4 m <sup>2</sup>	6	40
●	IE57002	IE57002R	24	MICRO DARK	80	2 x 2 · 4 m <sup>2</sup>	6	40
●	IE57003	IE57003R	24	MICRO DARK	90	2 x 2 · 4 m <sup>2</sup>	6	40
●	IE57004	IE57004R	24	MICRO DARK	100	2 x 2 · 4 m <sup>2</sup>	6	40
●	IE57005	IE57005R	24	MICRO DARK	120	2 x 2 · 4 m <sup>2</sup>	3	32
-	IE45040	IE45040R	27	INTEGRA	40	2 x 2 · 4 m <sup>2</sup>	6	40
-	IE45050	IE45050R	27	INTEGRA	50	2 x 2 · 4 m <sup>2</sup>	6	40
-	IE45000	IE45000R	27	INTEGRA	60	2 x 2 · 4 m <sup>2</sup>	6	40
-	IE45001	IE45001R	27	INTEGRA	70	2 x 2 · 4 m <sup>2</sup>	6	40
-	IE45002	IE45002R	27	INTEGRA	80	2 x 2 · 4 m <sup>2</sup>	6	40
-	IE45003	IE45003R	27	INTEGRA	90	2 x 2 · 4 m <sup>2</sup>	6	40
-	IE45004	IE45004R	27	INTEGRA	100	2 x 2 · 4 m <sup>2</sup>	6	40
-	IE45005	IE45005R	27	INTEGRA	120	2 x 2 · 4 m <sup>2</sup>	3	32



## COMPLETE SHOWER KIT REVOLUX RUBER KIT

Revolux Ruber Kit (with Ruber Drain)

PRODUCT							LOGISTICS	
	REF. RUBER H50	REF. RUBER H28	FLOW RATE (l/m)	MODEL	MEASURE (cm)	W-S MEBRANE (m)	PCS/BOX	PCS/PALLET
●	IE23004	IE23004R	28	CURVE CHROME	100	2 x 2 · 4 m <sup>2</sup>	6	40
●	IE63004	IE63004R	28	CURVE GOLD	100	2 x 2 · 4 m <sup>2</sup>	6	40
●	IE83004	IE83004R	28	CURVE ROSE	100	2 x 2 · 4 m <sup>2</sup>	6	40
●	IE53004	IE53004R	28	CURVE BLACK	100	2 x 2 · 4 m <sup>2</sup>	6	40
●	IE93004	IE93004R	28	CURVE NICKEL	100	2 x 2 · 4 m <sup>2</sup>	6	40
●	IE24004	IE24004R	29	CAVITY CHROME	100	2 x 2 · 4 m <sup>2</sup>	6	40
●	IE64004	IE64004R	29	CAVITY GOLD	100	2 x 2 · 4 m <sup>2</sup>	6	40
●	IE84004	IE84004R	29	CAVITY ROSE	100	2 x 2 · 4 m <sup>2</sup>	6	40
●	IE54004	IE54004R	29	CAVITY BLACK	100	2 x 2 · 4 m <sup>2</sup>	6	40
●	IE94004	IE94004R	29	CAVITY NICKEL	100	2 x 2 · 4 m <sup>2</sup>	6	40
●	IE23200	IE23200R	28	CURVE CHROME	200	2,5 x 2 · 5 m <sup>2</sup>	3	32
●	IE63200	IE63200R	28	CURVE GOLD	200	2,5 x 2 · 5 m <sup>2</sup>	3	32
●	IE83200	IE83200R	28	CURVE ROSE	200	2,5 x 2 · 5 m <sup>2</sup>	3	32
●	IE53200	IE53200R	28	CURVE BLACK	200	2,5 x 2 · 5 m <sup>2</sup>	3	32
●	IE93200	IE93200R	28	CURVE NICKEL	200	2,5 x 2 · 5 m <sup>2</sup>	3	32
●	IE24200	IE24200R	29	CAVITY CHROME	200	2,5 x 2 · 5 m <sup>2</sup>	3	32
●	IE64200	IE64200R	29	CAVITY GOLD	200	2,5 x 2 · 5 m <sup>2</sup>	3	32
●	IE84200	IE84200R	29	CAVITY ROSE	200	2,5 x 2 · 5 m <sup>2</sup>	3	32
●	IE54200	IE54200R	29	CAVITY BLACK	200	2,5 x 2 · 5 m <sup>2</sup>	3	32
●	IE94200	IE94200R	29	CAVITY NICKEL	200	2,5 x 2 · 5 m <sup>2</sup>	3	32

### Revolux Cavity



- Chrome ●
- Gold ●
- Rose ●
- Black ●
- Nickel ●

### Revolux Curve

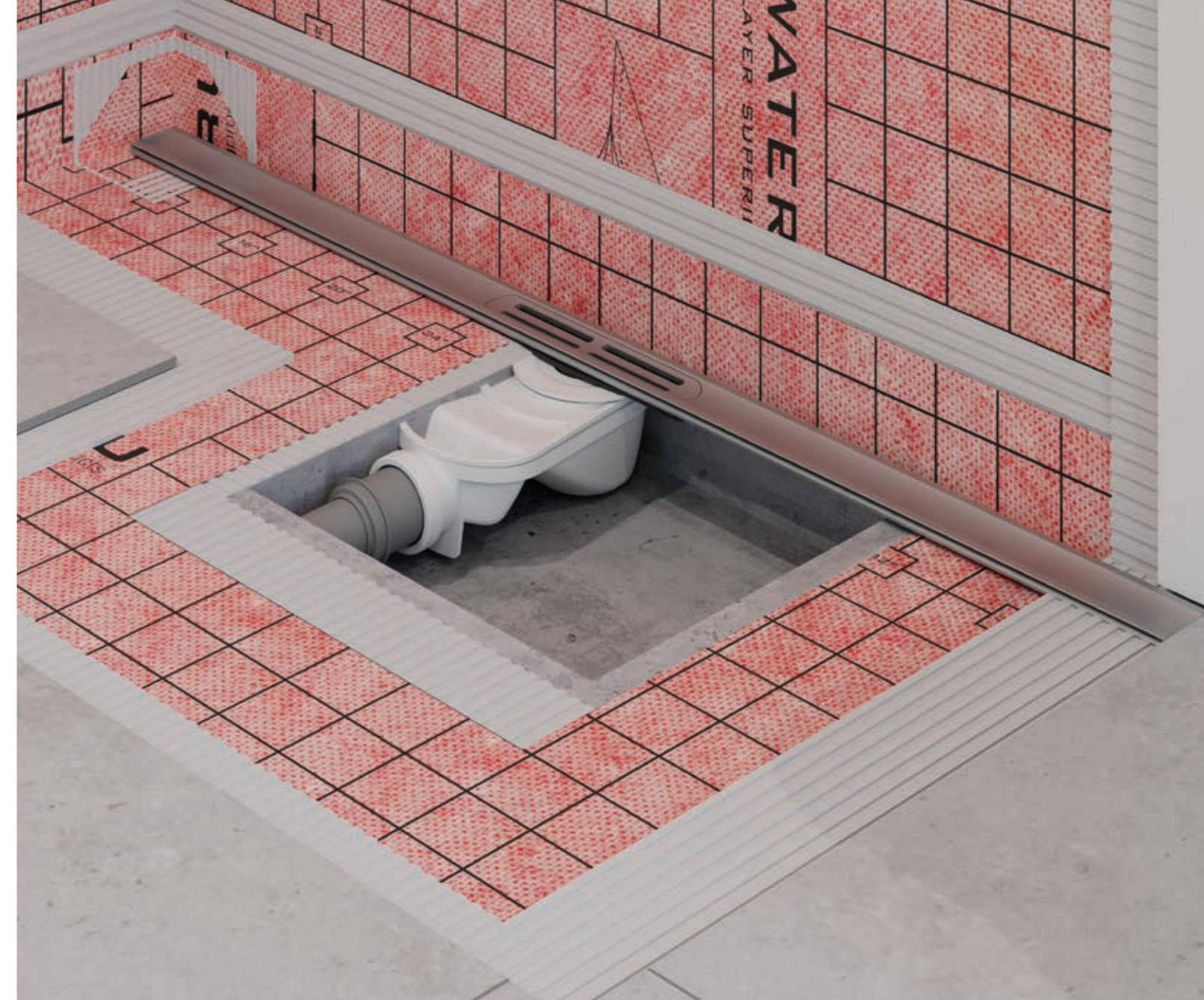

### The system includes



- 1- Drain of choice. 2- Grate, embellisher, and hair trap REVOLUX (model and size of choice). 3- Grate remover. 4- Mortar level cover. 5- W-S DIN x2 (inside corners).
- 6- W-S TUB x2 (pass-through pipes). 7- WATER-STOP membrane with thermosealed adapter (2 x 2 or 2.5 x 2.5 m). 8- Evolux Ruber Kit box.



## SHOWER KIT FOR VINYL FLOORS **EVOLUX VINYL**



Scan the QR code and discover more

Say goodbye to leaky vinyl floors.

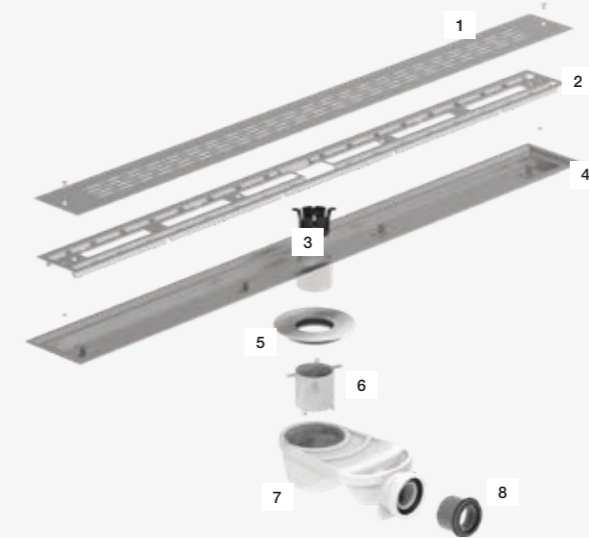
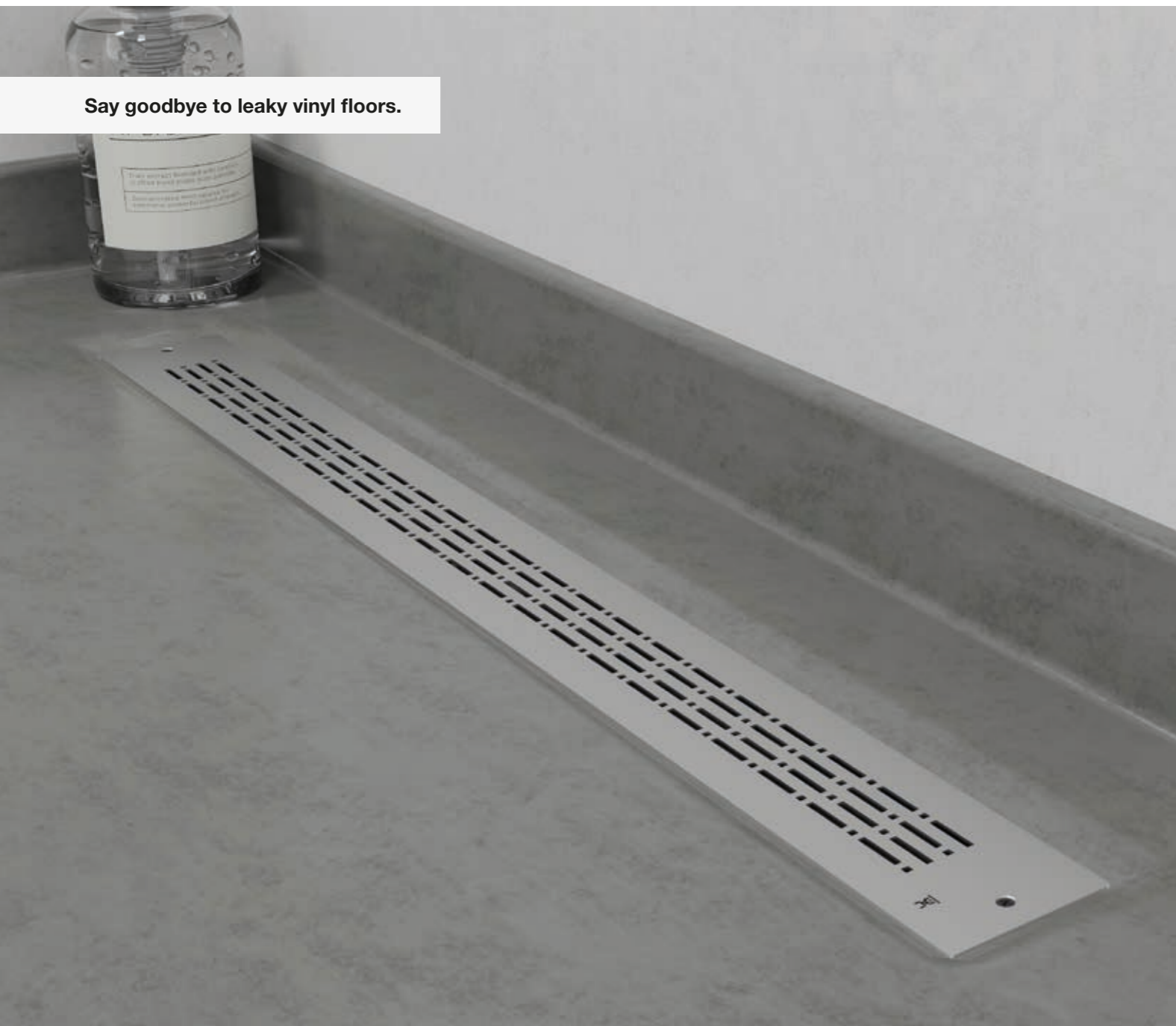

1. Evolux Vinyl grille
2. Framework
3. Hair collector
4. Vinyl Trough
5. Adapter
6. Rubber shower head
7. Rubber siphonic body
8. Reducer Ø 50/40 mm

### Features



- » Stainless steel structure
- » Watertightness assured
- » High drainage capacity
- » Hair collector included
- » Self-cleaning
- » Easy installation

### Specifications

- » Adjustable clamp from 1 mm to 5 mm
- » Antivandal
- » Stainless steel AISI 304

EVOLUX VINYL is our newest **vinyl floor drain** innovation. It is notable for its ability to maintain a waterproof seal in bathrooms and changing rooms, while also being **easy to install**.

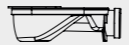
This kit comprises a gutter and a frame with a trim. It uses a watertight clamping system with MS putty to enable the installation of drainage in technical floors of hospitals, laboratories, wet rooms, etc.

PRODUCT					LOGISTICS	
REF. RUBER H50	REF. RUBER H28	MODEL	MEASURE (cm)	W-S MEMBRANE (m)	PCS/BOX	PCS/PALLET
		VINYL	15 x 15	0,4 x 0,4 · 0,4 m <sup>2</sup>	3	50
IE70001	IE70001R	VINYL	70	0,4 x 0,4 · 0,4 m <sup>2</sup>	6	40
IE70002	IE70002R	VINYL	80	0,4 x 0,4 · 0,4 m <sup>2</sup>	6	40
IE70003	IE70003R	VINYL	90	0,4 x 0,4 · 0,4 m <sup>2</sup>	6	40
IE70004	IE70004R	VINYL	100	0,4 x 0,4 · 0,4 m <sup>2</sup>	6	40



SHOWER SHELVES **SHELF**



Scan the QR code and discover more

Install your shower shelf without the need for any construction work!

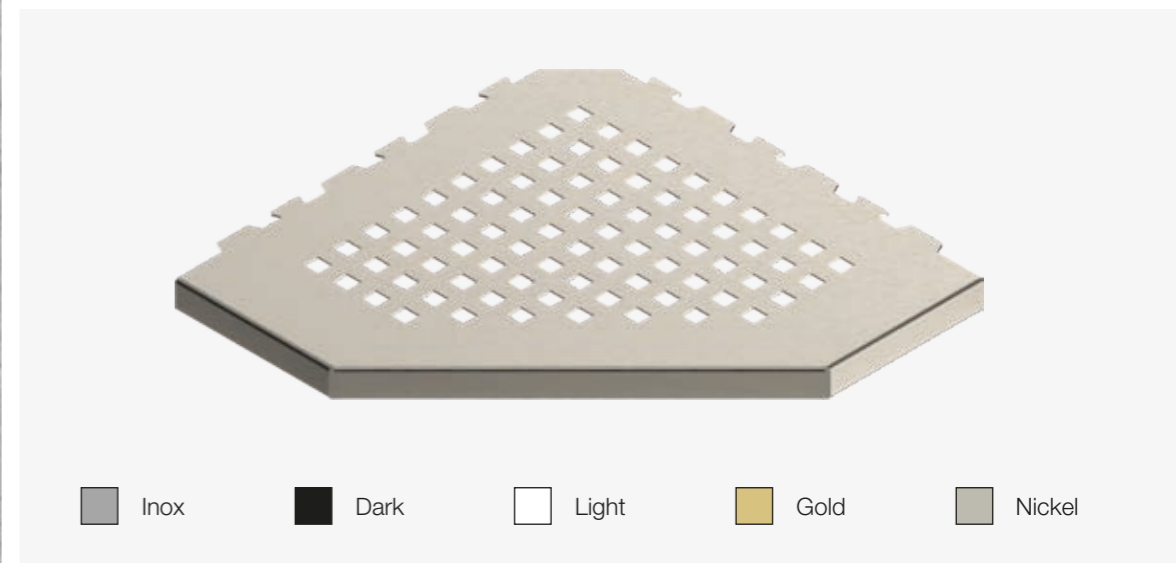

- Inox
- Dark
- Light
- Gold
- Nickel

**Features**

- » Easy installation in renovations and new constructions
- » Unique aesthetic finishes
- » Standard: UNE67100
- » No-drill installation (no risk of pipe breakage or loss of waterproofing)

**Specifications**

- » Thickness: 1 mm
- » Made of AISI 316 Stainless Steel - Marine Grade
- » Finishes in PVD, textured, and satinized

SHELF is a **shower shelf** that **eliminates the need for drilling** or any other form of installation that may damage walls or require building work.

Made from **AISI 316L stainless steel**, this product is highly resistant to corrosion, offering both durability and aesthetic appeal. Its design with 1 mm thickness **allows installations in joints of 1.5 mm between tiles**.

It is notable for its capacity to **support weights heavier than the standard** and for its **speedy and efficient installation**, taking less than 30 minutes.

**Triangle**

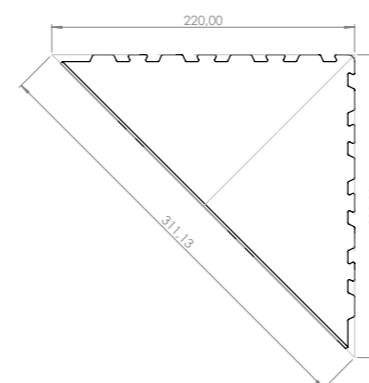

**Trapezoid**

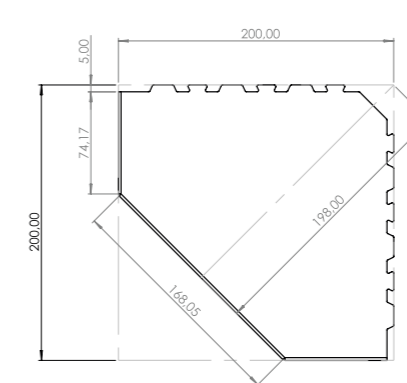

**Trapezoid Asim**

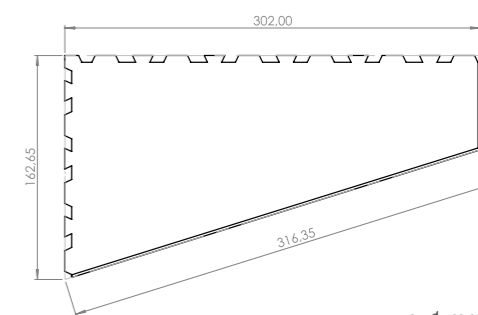

e=1 mm



## SHOWER SHELVES **SHELF**

Shelf

PRODUCT				LOGISTICS	
REF.	SHAPE	MODEL	FINISHED	PCS/BOX	PCS/PALLET
IZU0302	TRIANGLE	PLUS	INOX	11	297
IZU0301	TRIANGLE	PLUS	DARK	11	297
IZU0314	TRIANGLE	PLUS	NICKEL	11	297
IZU0300	TRIANGLE	PLUS	WHITE	11	297
IZU0004	TRIANGLE	BEAT	INOX	11	297
IZU0000	TRIANGLE	BEAT	DARK	11	297
IZU0005	TRIANGLE	BEAT	NICKEL	11	297
IZU0305	TRAPEZOID	PLUS	INOX	11	297
IZU0304	TRAPEZOID	PLUS	DARK	11	297
IZU0312	TRAPEZOID	PLUS	NICKEL	11	297
IZU0303	TRAPEZOID	PLUS	WHITE	11	297
IZU0006	TRAPEZOID	BEAT	INOX	11	297
IZU0001	TRAPEZOID	BEAT	DARK	11	297
IZU0007	TRAPEZOID	BEAT	NICKEL	11	297
IZU0008	TRAPEZOID	BEAT	WHITE	11	297
IZU0009	TRAPEZOID	BEAT	GOLD	11	297
IZU0308	TRAPEZOID ASIM	PLUS	INOX	11	297
IZU0307	TRAPEZOID ASIM	PLUS	DARK	11	297
IZU0313	TRAPEZOID ASIM	PLUS	NICKEL	11	297
IZU0306	TRAPEZOID ASIM	PLUS	WHITE	11	297

Shelf Triangle Plus



Shelf Triangle Beat



Shelf Trapezoid Plus



Shelf Trapezoid Beat



Shelf Trapezoid Asim Plus

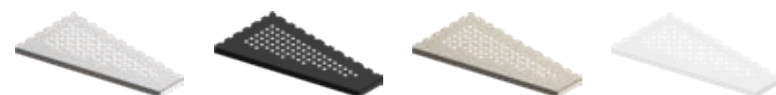



ACCESSORIES EVO / EVOLUX



REF.	DESCRIPTION	FINISHED
IG67004	BRACKET JOINT	SATIN

The EVOLUX range of shower systems is designed to be connected without the use of fasteners. For safe installation, our stainless-steel connecting bracket is available.

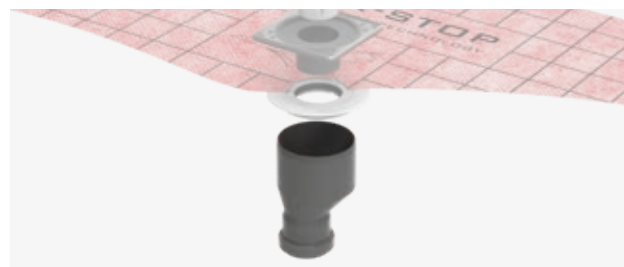

REF.	DESCRIPTION	MATERIAL
IG01143	VERTICAL OUTLET RUBER KIT	POLYPROPYLENE

RUBER drain adaptation kit for vertical outlet installation under the structure. It consists of an extension and an adapter

25 pcs.



REF.	DESCRIPTION	MATERIAL
IG60034	PACK 25 HAIR COLLECTORS	ABS

Pack of 30 hair collectors made of ABS.

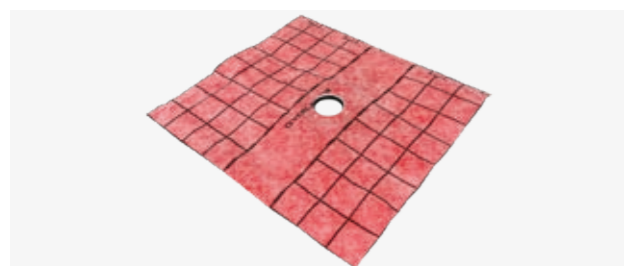

REF.	DESCRIPTION
IF55016	RUBER ADAPTER WITH 40 X 40 CM W-S MEMBRANE

A 40 x 40 cm piece of WATER-STOP membrane with an adapter for the RUBER sink, heat-sealed at the factory.



REF.	DESCRIPTION
IG60035	RUBER H50 DRAIN KIT
IG60030	RUBER H28 DRAIN KIT

Ruber Drain Kit. Option of standard and reduced height.



REF.	DESCRIPTION
IG60036	TRYPHON DRAIN KIT
IG60031	TRYPHON REDUCED DRAIN KIT
IG60032	TRYPHON VERTICAL DRAIN KIT

Tryphon Drain Kit. Option of standard and reduced height, and vertical outlet.

INSTALLATION PROFILES G-PRO WALL

Suitable for wall-mounted installation.

REF.	DESCRIPTION
IJ80008	GPRO-WALL 11,6 cm
IJ80009	GPRO-WALL 15 cm
IJ80006	GPRO-WALL 30 cm
IJ80007	GPRO-WALL 40 cm
IJ80000	GPRO-WALL 60 cm
IJ80001	GPRO-WALL 70 cm

REF.	DESCRIPTION
IJ80002	GPRO-WALL 80 cm
IJ80003	GPRO-WALL 90 cm
IJ80004	GPRO-WALL 100 cm
IJ80005	GPRO-WALL 120 cm
IJ80013	GPRO-WALL 150 cm
IJ80014	GPRO-WALL 180 cm



INSTALLATION PROFILES G-PRO LEVEL

Decorative trim profiles can be used to cover the side slope of the shower enclosure. They ensure a constant 2% slope in accordance with the CTE (Technical Building Code). High-quality steel notched trowel. They can come in satin or textured finishes and a variety of colours.

	REF.	DESCRIPTION	FINISHED
●	IJ80015	G-PRO LEVEL 120 cm	INOX
●	IJ80017	G-PRO LEVEL 120 cm	STONE
●	IJ80019	G-PRO LEVEL 120 cm	CHOCO
●	IJ80021	G-PRO LEVEL 120 cm	CREAM
●	IJ80023	G-PRO LEVEL 120 cm	GREY
○	IJ80025	G-PRO LEVEL 120 cm	WHITE
●	IJ80027	G-PRO LEVEL 120 cm	DARK

	REF.	DESCRIPTION	FINISHED
●	IJ80029	G-PRO LEVEL 120 cm	INOX
●	IJ80031	G-PRO LEVEL 120 cm	STONE
●	IJ80033	G-PRO LEVEL 120 cm	CHOCO
●	IJ80035	G-PRO LEVEL 120 cm	CREAM
●	IJ80037	G-PRO LEVEL 120 cm	GREY
○	IJ80039	G-PRO LEVEL 120 cm	WHITE
●	IJ80041	G-PRO LEVEL 120 cm	DARK





## MADE-TO-MEASURE KIT **EVOLUX BASE + CHANNEL AND GRATE**

Our base kit is a comprehensive solution that includes the Ruber drain, corner pieces, and the WATER-STOP waterproofing membrane. This set is the cornerstone for the drainage system. But it doesn't end there, as in addition to the base kit, you can choose from various sizes and finishes in our channel + grate options.

### EVOLUX BASE (BOX 1)

Contains the trap body, waterproofing and accessories. Combine with a SHOWER CHANNEL + GRATE.

REF.	DESCRIPTION	MEDIDA
IC30003	SISTEMA EVOLUX BASE	3 m <sup>2</sup>
IC30004	SISTEMA EVOLUX BASE	4 m <sup>2</sup>
IC30003R	SISTEMA EVOLUX BASE	3 m <sup>2</sup>
IC30004R	SISTEMA EVOLUX BASE	4 m <sup>2</sup>



### CHANNEL AND EVOLUX GRATE (BOX 2)

Combine the shower channel and grate of your chosen model with the Evolux Base System.

FINISHED	REF.	MODEL	MEASURE (cm)
●	ID30100	LISA	11,6 x 11,6
●	ID30200	LISA	15 x 30
●	ID30300	LISA	60
●	ID30400	LISA	70
●	ID30500	LISA	80
●	ID30600	LISA	90
●	ID30700	LISA	100
●	ID30800	LISA	120
●	ID31150	LISA	150
●	ID31180	LISA	180
●	ID30101	PLUS	11,6 x 11,6
●	ID30201	PLUS	15 x 30
●	ID30301	PLUS	60
●	ID30401	PLUS	70
●	ID30501	PLUS	80
●	ID30601	PLUS	90
●	ID30701	PLUS	100

### CHANNEL AND EVOLUX GRATE (BOX 2)

Combine the shower channel and grate of your chosen model with the Evolux Base System.

FINISHED	REF.	MODEL	MEASURE (cm)
●	ID30801	PLUS	120
●	ID32150	PLUS	150
●	ID32180	PLUS	180
-	ID30104	INTEGRA	11,6 x 11,6
-	ID30204	INTEGRA	15 x 30
-	ID30304	INTEGRA	60
-	ID30404	INTEGRA	70
-	ID30504	INTEGRA	80
-	ID30604	INTEGRA	90
-	ID30704	INTEGRA	100
-	ID30804	INTEGRA	120
-	ID35150	INTEGRA	150
-	ID35180	INTEGRA	180
○	ID40209	CRISTAL	15 x 30
○	ID40409	CRISTAL	70
○	ID40509	CRISTAL	80
○	ID40609	CRISTAL	90
●	ID50100	LISA DARK	11,6 x 11,6
●	ID50200	LISA DARK	15 x 30
●	ID50300	LISA DARK	60
●	ID50400	LISA DARK	70
●	ID50500	LISA DARK	80
●	ID50600	LISA DARK	90
●	ID37100	MICROCEMENT	11,6 x 11,6
●	ID37200	MICROCEMENT	15 x 30
●	ID37300	MICROCEMENT	60
●	ID37400	MICROCEMENT	70
●	ID37500	MICROCEMENT	80
●	ID37600	MICROCEMENT	90
●	ID37700	MICROCEMENT	100
●	ID37800	MICROCEMENT	120



**DRY CONSTRUCTION PANEL W-S BOARD**



Scan the QR code and discover more

**Waterproof and build simultaneously... No building work required!**

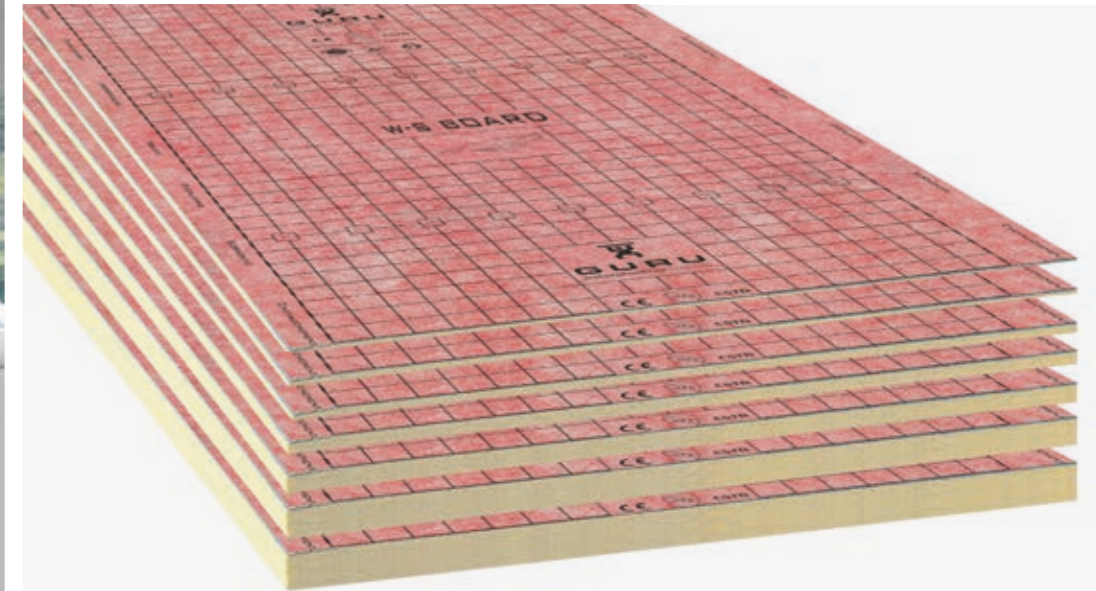

**Features**

- » Reduces installation time
- » Available sizes:  
910 x 1520 / 2600 x 625 / 2440 x 1220 mm
- » Available thicknesses: 12.5 / 50 mm

**Specifications**

- » Compression Strength:  
400 KPA - 50 PSI
- » Thickness from 12,5 mm to 50 mm
- » 0.3 perms - ideal for steam shower

W-S BOARD is a **waterproof drywall construction panel** that is versatile, **easy to cut**, and **adaptable** to various construction scenarios.

With a **variety of thicknesses and sizes** available, it is suitable for any project, from residential to industrial construction.

Its **waterproof** feature provides resistance to moisture and offers long-lasting protection against leaks and condensation. Furthermore, its consistent flatness ensures **uniform finishes** and a **strong grip** on the ceramic itself.

The dry installation system with **screw fixing** accelerates the construction process, reducing both **time and costs**.

REF.	DESCRIPTION	MEASURE (mm)	UDS/PALLET
IMU9300	W-S BOARD PANEL	910 x 1520 x 12,5	80
IMU9301	W-S BOARD PANEL	2440 x 1220 x 12,5	80
IMU9317	W-S BOARD PANEL	2600 x 625 x 50	20

REF.	DESCRIPTION	QUANTITY
IG60026	SCREWS	200 pcs.
IG60027	METAL WASHERS	200 pcs.
IG60028	SCREW + WASHER KIT	200 pcs. (100 pcs. of each)



# GURU CUSTOMISED



## GURU IN PROJECTS

We can customise the shower grates with your logo, brand, city... whatever design is required to create a unique experience for your hotel!

## GIVE IT A PERSONAL TOUCH!

Estil Guru creates custom projects to enhance the hospitality experience. Our focus is on two crucial aspects: structural waterproofing and customising bathrooms with high-end showers.

During the waterproofing phase, Estil Guru will conduct a thorough evaluation of the structure, identifying vulnerable areas and preventing any moisture-related issues. Simultaneously, we will analyse the requirements and products that are most appropriate for each situation: Bathroom, spa, shower, terrace, room, deck, patio, swimming pool...

Our focus is also on shower systems, creating modern and personalised spaces to provide unique experiences. This statement highlights not only our dedication to creating modern, leak-free bathrooms but also our commitment to sustainability and competitive differentiation in the shower and waterproofing sector.

Additionally, we would like to emphasise the meticulous planning of our technical team. They carefully schedule all tasks to minimise any inconvenience to our clients and prepare the budget with a commitment to providing the best value for money and the highest quality.



# GURU SANITARY

## GURU IN HOSPITAL AND NURSING HOME PROJECTS

We design bespoke, integrated projects for hospitals and care homes. Our focus is on the construction and renovation of essential spaces. We ensure durability and resistance by waterproofing all necessary areas. Additionally, we design modern and functional bathrooms and communal areas.

Our approach centres around waterproofing, which involves a thorough assessment of structures. We conduct customised studies to identify vulnerable areas and prevent leaks and damp-related problems. We then recommend the best solution for each case.

Our innovative shower systems, including waterproofing with Evolux Vinyl, set us apart in the industry. This shower system is designed and manufactured to be integrated into vinyl floors of hospitals and nursing homes, ensuring waterproofing and high drainage effectiveness.

At Estil Guru, every project is a testament to our dedication to quality, sustainability, and elevated comfort. We strive to create spaces that make a difference in everyday life.





OUR PRODUCTS AT **bimobject**

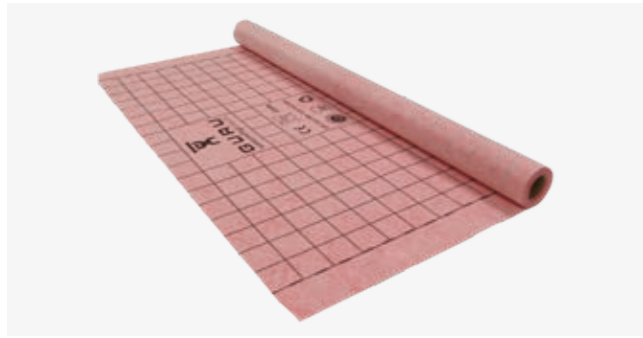

**WATER-STOP**  
Waterproofing membrane.

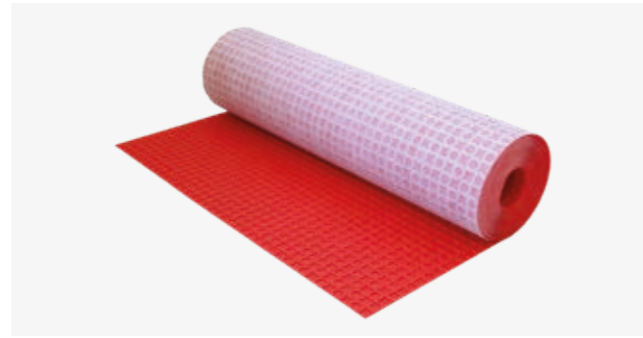

**G-FLEX**  
Decoupling membrane.

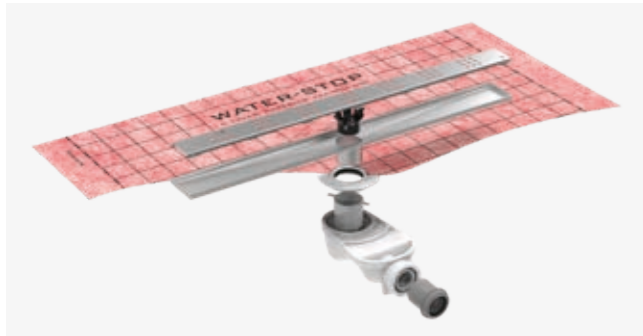

**EVOLUX RUBER KIT LISA/PLUS/DARK**  
Complete shower kit with included waterproofing.

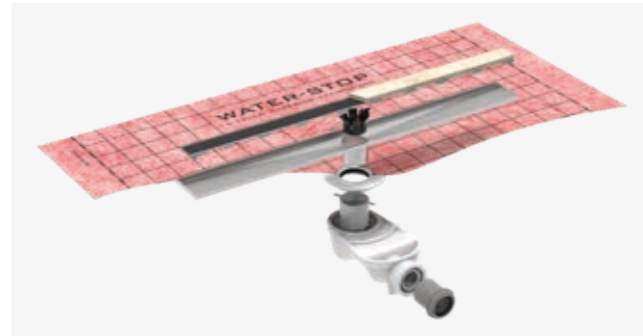

**EVOLUX RUBER KIT INTEGRA**  
Complete pavable shower kit with included waterproofing.

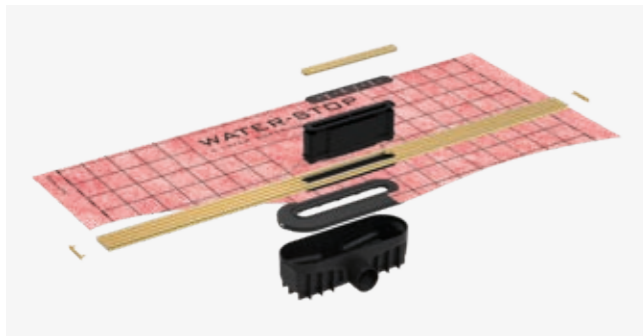

**REVOLUX TRYPHON KIT**  
Complete shower kit with included waterproofing and cut out grate.

FIND OUR PRODUCTS ALSO IN:



**Multibrand Catalog**  
Prices, CAD, and BIM for AEC (Architecture, Engineering, and Construction).



**Price Generator**  
CYPE is a multiparametric price bank available for new construction, rehabilitation, and urban spaces.

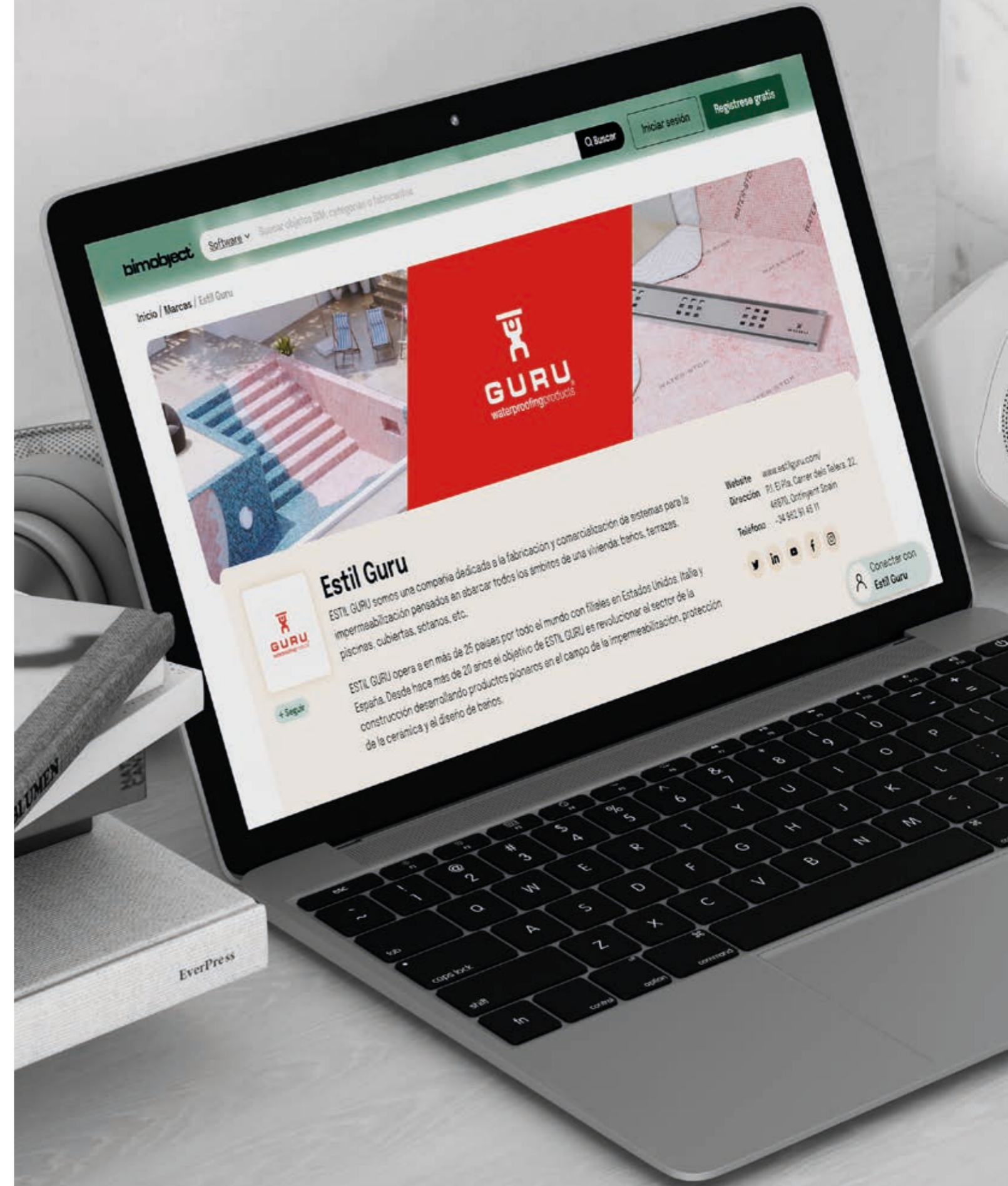



INSTALLATION **VIDEOS**



WATER-STOP



RUBER DRAIN



G-FLEX



G-FLEX (NEGATIVE MOISTURE)



SAFE BAND  
BATHTUB



EVO RUBER KIT



SAFE BAND  
SHOWER TRAY



EVOLUX RUBER KIT



REVOLUX RUBER KIT



EVOLUX INTEGRA RUBER KIT



REVOLUX TRYPHON KIT



EVOLUX TRYPHON KIT

INSTALLATION **GUIDES**



WATER-STOP SHOWERS



EVOLUX (TRYPHON)



WATER-STOP POOLS



REVOLUX (TRYPHON)



WATER-STOP OUTDOORS



EVOLUX INTEGRA (TRYPHON)



G-FLEX



EVOLUX SQUARE (RUBER)



SAFE BAND



EVOLUX LINEAL (RUBER)



RAYNEX



EVOLUX INTEGRA (RUBER)



REVOLUX (RUBER)





REF: MK00035  
DESCRIPTION: General Pricelist GURU 2024. A4 size.



REF: IP00834  
DESCRIPTION: Shower system finishes quadriptych. A4 size.



REF: IP01001  
DESCRIPTION: Estil Guru general brochure. A5 size.



REF: MK00030  
DESCRIPTION: Technical plates triptych. It contains information about each of them and a real sample of each of them. A4 size.

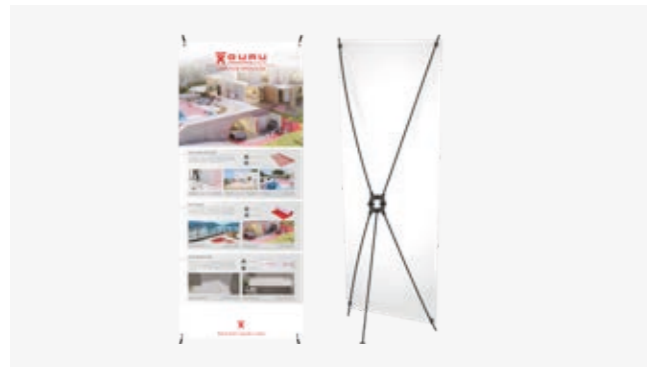

REF: IP01723 (Membranes)  
DESCRIPTION: 70 x 180 cm canvas banner.



REF: IP01724 (Shower systems)  
DESCRIPTION: 70 x 180 cm canvas banner.



REF: IP01064  
DESCRIPTION: Leaflet holder. 3 different designs.



REF: MK00016  
DESCRIPTION: Shower system finishes quadriptych. A4 size.

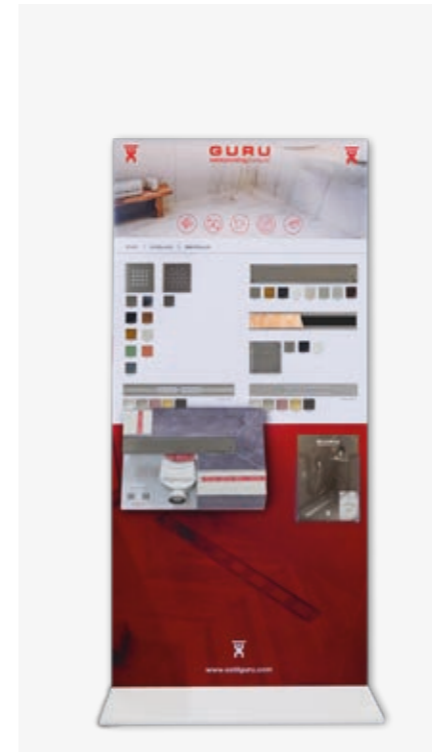

REF: MK01126  
DESCRIPTION: Real model in the EVOLUX-REVOLUX finished display.



REF: MK00019  
DESCRIPTION: WATER-STOP and accessories metal display case.



REF: MK00020  
DESCRIPTION: EVOLUX and accessories metal display case. It comes with real models.



REF: MK00021  
DESCRIPTION: Metal display case including WATER STOP and an extra roll.



REF: MK00022  
DESCRIPTION: Metal display case including Evolux with accessories and a roll of WATER-STOP membrane. It comes with real models.



REF: MK00018  
DESCRIPTION: EVOLUX SHELF tower display.  
**FREE GIFT WITH AN ORDER OF 16 UNITS.**



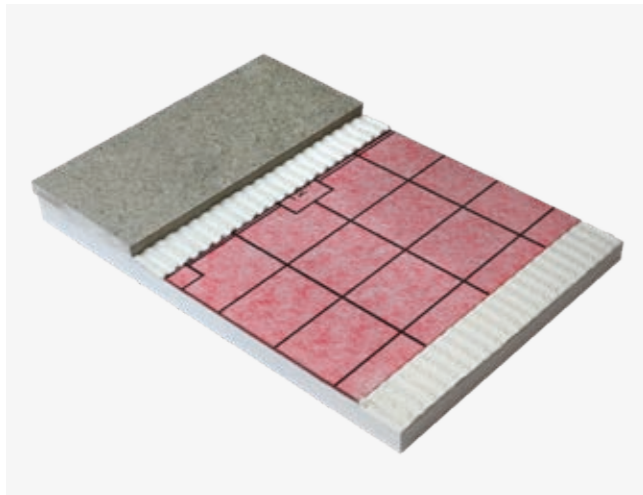

REF: MK00024  
DESCRIPTION: Real model WATER-STOP.



REF: MK00023  
DESCRIPTION: Real model G-FLEX.

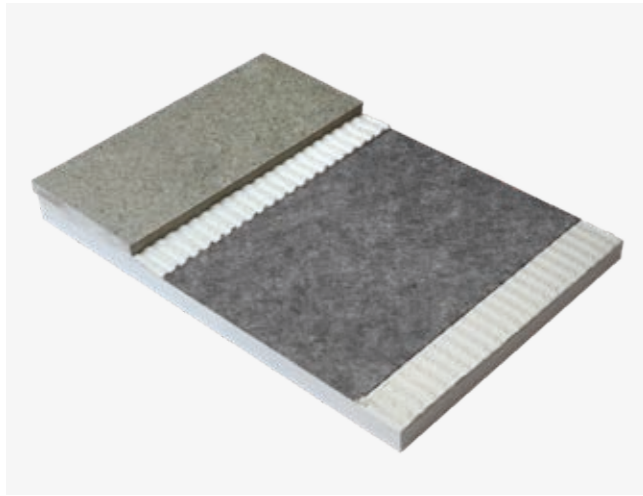

REF: MK00008  
DESCRIPTION: Real model G-SOUND.



REF: MK00025  
DESCRIPTION: Real model SAFEBAND.



REF: MK00010  
DESCRIPTION: Real model RAYNEX.

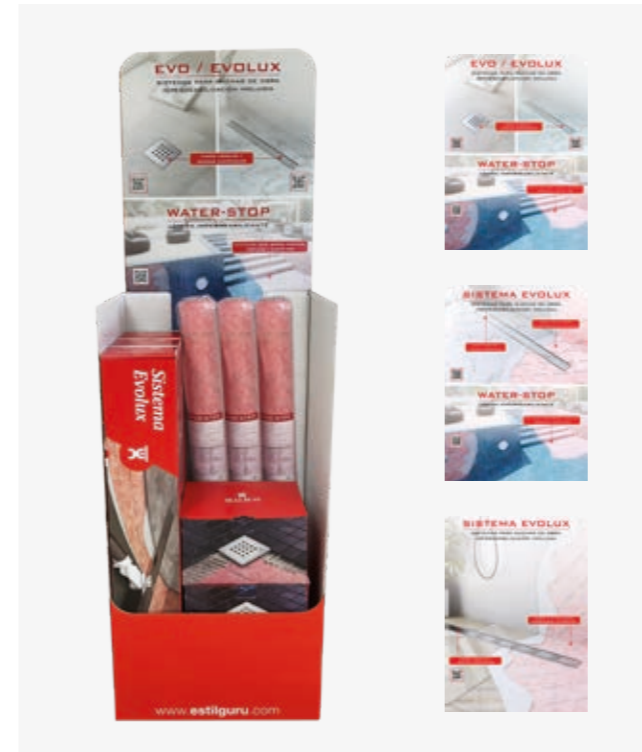

REF: IP00130 / IP00147 / IP01394  
DESCRIPTION: Container box. 3 gusset options (EVOLUX / EVOLUX+W-S / EVO + EVOLUX+W-S).



REF: MK00017  
DESCRIPTION: SAFEBAND table-top display. 8 units included in the pack.



REF: MK00011  
DESCRIPTION: EVOLUX SHELF for tabletop display. Includes sample and assembly models.  
**FREE GIFT WITH AN ORDER OF 10 UNITS.**



FEATURED PROJECTS



CENTRO DE AMAZON  
(Bilbao y Vizcaya, España)



PARQUE DE BOMBEROS ARRATZU  
(Vizcaya, España)



LINO DELLE FATE  
(Bibiona, Italia)



UNIVERSIDAD MOHAMED VI  
(Rabat, Marruecos)



COMPLEJO DEPORTIVO  
(Mendizorroza, España)



PISCINA MUNICIPAL  
(Ávila, España)



FÁBRICA 1921  
(Oporto, Portugal)

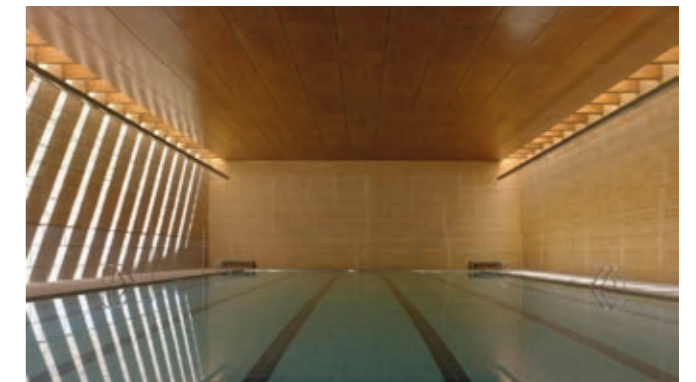

PISCINA MUNICIPAL  
(Toro, España)



RESIDENCIA CLAUDIO COELLO  
(Madrid, España)



SHERATON ARABELLA GOLF \*\*\*\*\*  
(Mallorca, España)



HOTEL LOPESAN BAOBAB  
(Las Palmas, España)

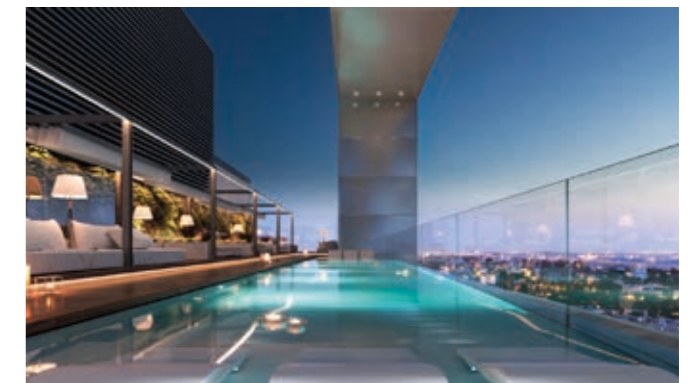

PROYECTO SKYLINE  
(Madrid, España)



CENTRO ATENCIÓN INTEGRAL LAS HAYAS  
(Navarra, España)

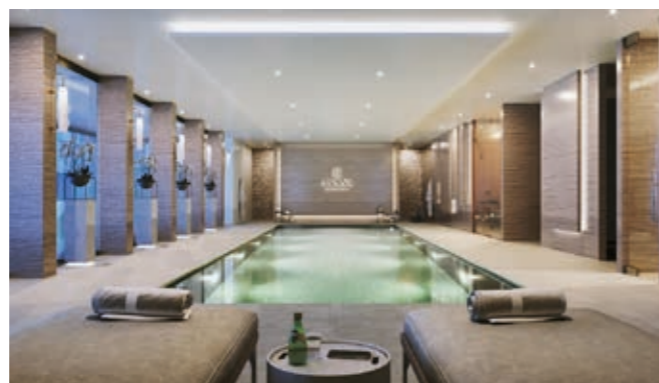

AYANA RESORT  
(Estepona, España)



PATRIMI GOLF RESORT  
(Alicante, España)



CENTRO IMED  
(Alicante, España)



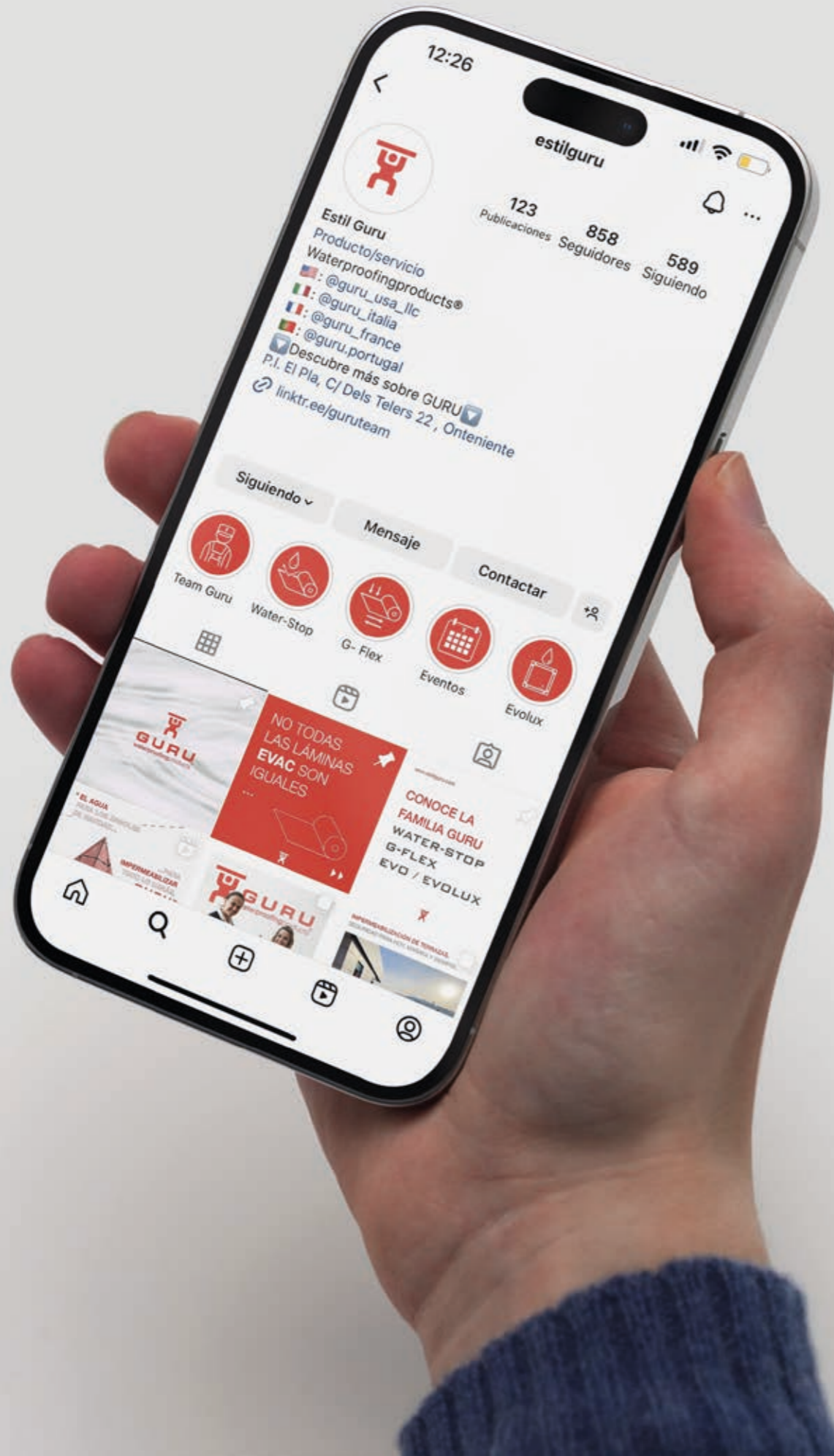

## GURU TEAM

**Still not following us on any of our socials?**  
We are on **Instagram, Facebook, LinkedIn and YouTube.**

We help you grow! If you post photos of our products and tag us **@estilguru**, we can help you increase your social media impact.

We are building a great community with TEAM GURU and are looking forward to meeting you. Are you in?









**ESTIL GURU SLU**

Pol. Ind. El Pla, C/ Dels Telers 22, 46870, Ontinyent

Valencia, ESPAÑA

Tel.: 96 291 45 11

[guru@estilguru.com](mailto:guru@estilguru.com)

[www.estilguru.com](http://www.estilguru.com)